

HB-LASER



GERMANY

HB-PROJECTS



GERMANY

HB-HYDRO



GERMANY

**MAKE
YOUR
PROJECTS
UNIQUE**



BRING EMOTIONS INTO DARKNESS

WE ARE YOUR PARTNER

- * 3D Laser
- * 3D Video-Mapping
- * 3D Water Fountains
- * Customized Multimedia Solutions

CERTIFIED & AWARD-WINNING

- * Founded in 1990
- * Certified Quality / DIN ISO 9001
- * Over 40 national & international awards for products, installations & shows

HB-PROJECTS



GERMANY

MAKE
YOUR
PROJECTS
UNIQUE

HB-LASER



GERMANY

EXCELLENCE
IN LASER &
MEDIA
TECHNOLOGY

HB-HYDRO



GERMANY

FOUNTAINS
& WATER
TECHNIQUE IN
PERFECTION

CONTENT

HB-PROJECTS

Worldwide Experience 4 - 5

FIXED INSTALLATIONS

Place Vendome Mall – Doha / Qatar 6 - 9

Multimedia Installation – Zlatibor / Serbia 10 - 11

Statue of Unity – Gujarat / India 12 - 15

Al Noor Island – Sharjah / UAE 16 - 17

Museums & Planetariums worldwide 18 - 23

Caves & Salt Mines 24 - 27

Teng Long Cave – Hubei / China 28 - 29

Amusement Parks 30 - 31

Cruise Ships 32 - 33

Clubs & Discotheques 34 - 35

EVENTS

Event Installations – Indoor & Outdoor 36 - 41

Realization of an Event 42 - 43

HB-LASER

Who we are 44 - 47

LightCube Series 48 - 55

Laser Accessories, OEM Products 56 - 58

Climate Housings / Weather Protection 59

Projection Screens 60 - 61

IVS – Interactive Visions 62 - 65

Sound Systems 66 - 67

HB-HYDRO

Our Experience in Water Installations 68 - 69

3D Hydro Matrix 70 - 75

Hydro Screens 76 - 79

3D Water Fountains 80 - 89

Our New Dry Deck Technology 90 - 95

THE HB-LASER COMPETENCIES COMPACT 96 - 99

HB-PROJECTS



GERMANY

**MAKE
YOUR
PROJECTS
UNIQUE**

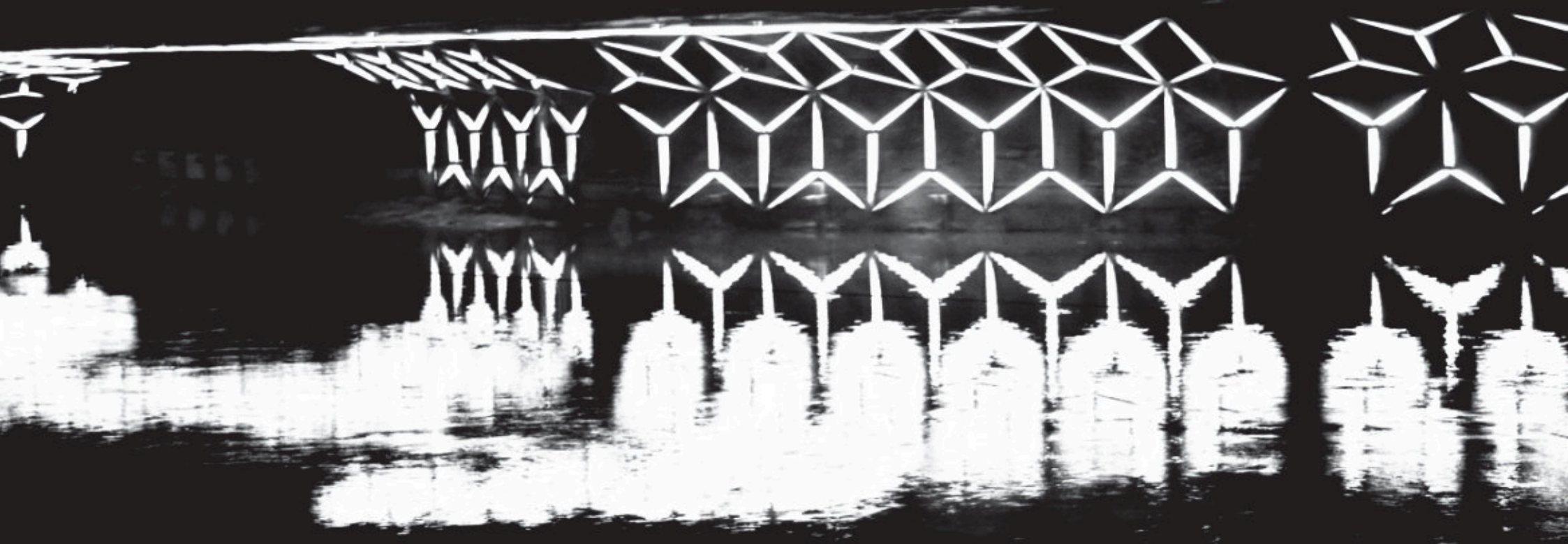



**MEDIA TECHNOLOGY, CONSULTING, CONCEPTION,
DEVELOPMENT & MANUFACTURING**

We convert your event, your project, your building
or your venue into a real experience.

WORLDWIDE EXPERIENCE

WE ARE YOUR PARTNER

Since 1990 HB-Laser has been developing and realizing multimedia projects and installations worldwide to full satisfaction of our customers. On the following pages you will get an insight into our references from all areas of application.

With highest motivation we are happy to turn your ideas into reality. Please contact us and our team is looking forward to developing and realizing unique, creative and technical solutions for you.

KNOW-HOW & EXPERIENCE FOR DESIRED SUCCESS

Technical solutions for video projections, video mappings and art installations, lighting technology, LED mapping technology and audio installations are part of our customized services and experience. A special challenge is to install the complete technology invisible and with special protection due to climatic conditions.

www.hb-projects.com

FIXED
MULTIMEDIA INSTALLATION
PLACE VENDOME
DOHA / QATAR



PLACE VENDOME – FIXED INSTALLATION

In the heart of Qatar, the Place Vendome Mall stands as a beacon of luxury and innovation, showcasing the pinnacle of multimedia entertainment in one of the largest shopping centers in the Arab world. Entrusted with the task of bringing this vision to life, HB-Laserkomponenten GmbH embarked on a monumental project to create a mesmerizing multimedia show that seamlessly integrates water fountains, video mapping, laser projections and sound effects, centered around the mall's expansive 150 x 80 m pool.

The project features over 250 custom-designed and manufactured water fountains, including Neptune HydroShields dancing to the rhythm of light and sound, creating a spectacle of water artistry. To complement the aquatic display, nine LightCube laser systems from the esteemed HB-Laser line were deployed for graphic projections and laser effects, illuminating the night with vibrant colors and intricate patterns.

A groundbreaking 3D video-mapping show utilizes 24 Barco video projectors, each boasting 32,000 ANSI lumens and 4K resolution, casting a breathtaking visual feast across the mall's 180m-wide facade. This visual marvel is rendered through a redundant setup, ensuring uninterrupted awe for the audience. The meticulously designed outdoor sound system, comprising PR-electronic components, envelops the space in immersive audio. Perfectly synchronized with the visual extravaganza to captivate your senses.

Since its inauguration in 2022, the Place Vendome Mall has become a nighttime destination for thousands of visitors, each drawn to the unparalleled multimedia shows that transport them into a world of fantasy and emotion. The technical prowess behind this marvel includes a suite of cutting-edge equipment.



PLACE VENDOME – FIXED INSTALLATION

INSTALLED TECHNOLOGY

- » 9 HB-Laser LightCube systems (14W + 30W RGB)
- » 24 Barco UDX 4K32 projectors
- » 2 Disguise 4x4Pro video-mapping servers
- » 1 PR-electronic outdoor sound system
- » An array of Neptune water effects, including HydroShields, VarioStream, MoveStream 3D, RotoJet and Octopus
- » 1 GrandMA controller for precise orchestration with time-code synchronization



PLACE VENDOME – FIXED INSTALLATION

Every piece of video and laser technology is housed in custom-designed, climate-controlled, IP65-rated enclosures, ensuring durability and performance in the outdoor setting of the mall.

This project stands as a testament to HB-Laserkomponenten GmbH's commitment to delivering tailor-made solutions that not only meet but exceed the expectations of its clients. The Place Vendome Mall project is a shining example of how innovative technology and creative vision can come together to create something truly extraordinary.



**FIXED
MULTIMEDIA
INSTALLATION
ZLATIBOR / SERBIA**



ZLATIBOR / SERBIA – FIXED INSTALLATION

In the scenic Serbian holiday region of Zlatibor, a tourist center has been enhanced with a 200 x 65 m artificial lake, aiming to attract more visitors through a captivating multimedia show concept centered around the lake. HB-Laser was commissioned to bring this vision to life, creating an engaging spectacle that utilizes the lake as a focal point for nightly multimedia shows every hour. The implementation featured a Neptune HydroShield for displaying advertisements, information, and shows with video and laser graphics, alongside 12 Neptune VarioStreams and 11 Neptune MoveStreams with LED lighting.

This tailor-made solution included 3 HB-Laser LightCube 14W lasers, a Christie D20HD video projector, a Titan video server and laser controller, and a PR-electronic outdoor sound system, all housed in climate-controlled, weatherproof IP65 enclosures, demonstrating HB-Laser's capability to deliver customized, innovative solutions that captivate and engage.



FIXED
INSTALLATION
STATUE OF UNITY
GUJARAT / INDIA



STATUE OF UNITY – FIXED INSTALLATION

„ONE OF THE PROJECTS WE ARE VERY PROUD OF.“

Mapping the largest statue in the world with both video and laser was a special challenge. Special thanks to our partners Pyramid Technologies, LNT and Christie, this enormous project could be realized in only 2.5 months.

HB-Laser was able to implement the complete planning including the projection center, cooling systems, switch cabinets and control technology in only 3 weeks. The production of all LightCube OPSL laser systems and the 51 video racks with special mirror technology was implemented in-house in record time.

Only 20 days before the opening, the construction of the technical building planned by HB-Laser started – but we did it!

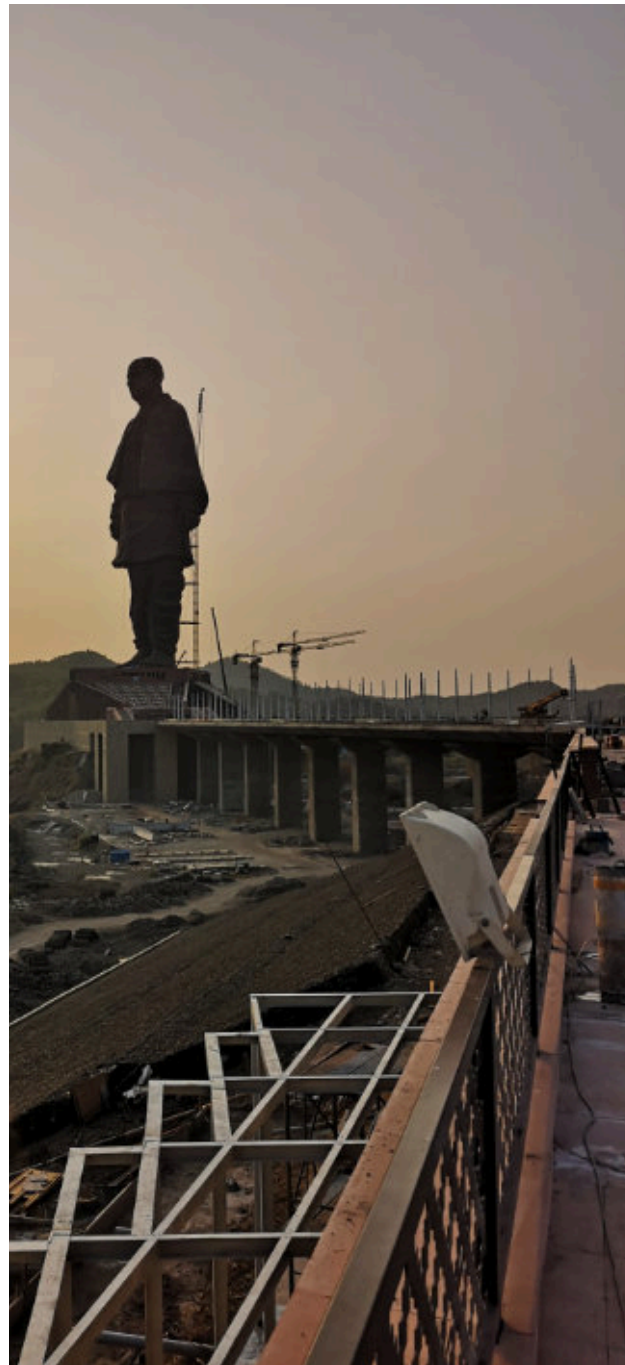

STATUE OF UNITY – FIXED INSTALLATION

Under the direction of HB-Laser, the complete projection building was erected on site – including 250 kw of a condensate-free special cooling system and the entire control technology.

At the same time, during the construction of the building, the installation of the video and laser technology was started.

In Germany as well the HB employees were not idle, simultaneously and in coordination with the processes in India producing the technical part of the 3D content for the 3D video-mapping – as well as the complete laser programming on site. Thus, the tight schedule could be kept to the complete satisfaction of the customer.

INSTALLED TECHNOLOGY

- » 51 Christie Crimson 25k laser, video projectors
- » Disguise 4 x 4 pro video server
- » Titan Laser and sound controller
- » 6 LightCube OPSL high-end low divergence laser systems
- » HB-Lox remote control and management system

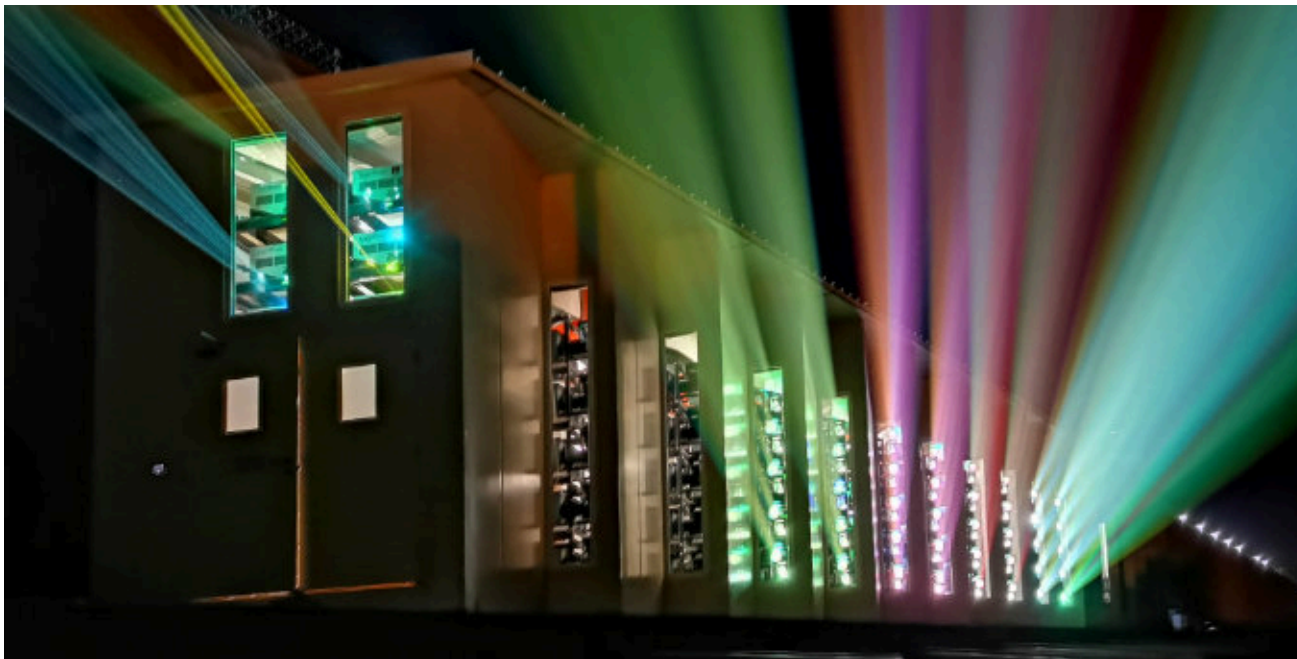





**FIXED
INSTALLATION
AL NOOR ISLAND
SHARJAH / UAE**

AL NOOR ISLAND – FIXED INSTALLATION

In cooperation with 3deluxe, HB-Laser developed the technical solutions for video projections and video mappings to bring art installations like „Glowing Meadows“ and „Glowing Trees“ to life. Additionally, the more than 2.2 km long walking path was installed with lighting technology, LED mapping technology and an audio system. This posed a special challenge, as the entire outdoors technology had to be almost invisible and specially protected due to the climatic conditions (0-55°C up to 90% humidity). Our know-how and years of experience working with difficult environments led to the desired success.

INSTALLED TECHNOLOGY:

- » LED pixel mapping & lighting
- » IP68 3D video mapping custom implementation
- » fiber flower field custom implementation
- » IP67 sound system custom implementation
- » Control solutions
- » IP68 projection techniques
- » Custom made IP68 laser
- » Custom made IP67 cooling system



**FIXED
INSTALLATIONS
MUSEUMS & PLANETARIES
WORLDWIDE**



MUSEUMS – FIXED INSTALLATION

It doesn't matter whether historical happenings, cultural monuments or museums with ambitious historical issues, HB-Laser demonstrates expertise in many demanding installations. These monuments of history are shown as widely visible highlights.

Turnkey solutions is what many planetariums and museums expect from their multimedia partners. HB-Laser often proved their experience in not only doing spectacular laser and video installations for museums, but also providing furniture, interactive areas or the individual creation of themed rooms or areas. Many different applications with laser, video, water or other effects can be combined to tell history, stories or any scientific topic. The development of 'Edutainment' systems are one of HB-Laser's core competencies.

This page shows the examples TEHRAN & AZADI / IRAN.



FLAME FURNACE MUSEUM – FIXED INSTALLATION

KOENIGSBRONN / GERMANY

In cooperation with ATELIER STURM, HB-Laser developed the Flame Furnace museum in Königsbronn in Germany. In addition to lighting and video technology in IP67 design, the special challenge was to revive the historic flame furnace for the production of hard cast iron wheels.

With special LED technology, epoxy resins and silicon technology HB-Laser was able to realize this show-piece in an amazingly realistic way.



LIMES MUSEUM – FIXED INSTALLATION

AALEN / GERMANY

In cooperation with ATELIER BRÜCKNER HB-Laser developed the technical solution for video projections and touch displays, installing the lighting and media technology for the Limesmuseum Aalen in Germany.

Everything is centrally controlled and monitored via HB-Lox Control.

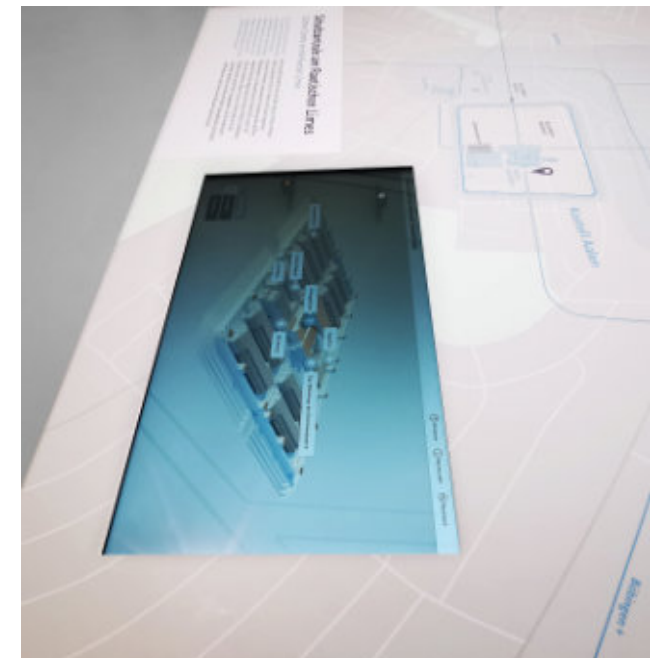

PLANETARIUMS – FIXED INSTALLATION

The particular challenge with laser for planetariums is to achieve a stable color balance. Especially when dimming down to zero, the colors should not change. The noise level of coolers and scanners should also be taken into account.

LightCube laser systems leave nothing to be desired in this respect.

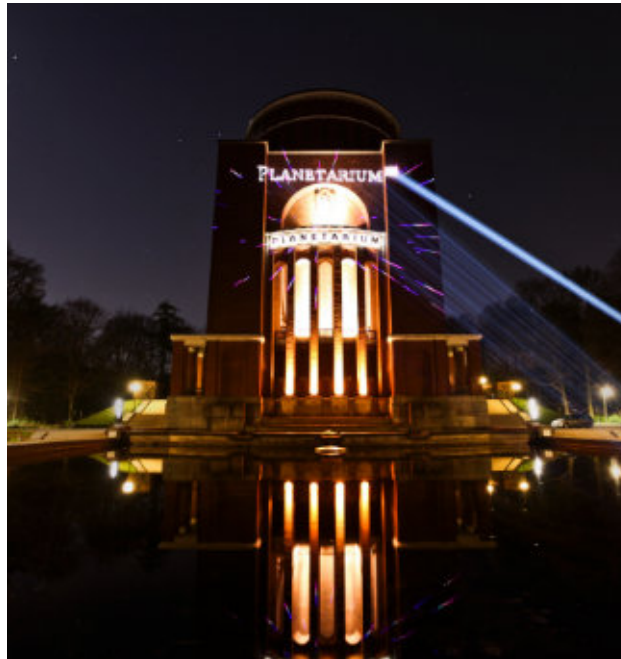

PLANETARIUM HAMBURG – HAMBURG / GERMANY

INSTALLED TECHNOLOGY:

- » LightCube Laser Systems
- » ZEUS systems
- » Fibre laser systems
- » Substitution of the existing technology
- » Combination of high performance systems



COPERNICUS SCIENCE CENTRE – WARSAW / POLAND

INSTALLED TECHNOLOGY:

- » LightCube Laser Systems
- » Titan controller
- » Special fog system
- » Active safety system
- » Seamless integration into multimedia planetarium control
- » Newly developed laser-tracking security system
- » 360° projections for full-dome mapping possible



PLANETARIUMS – FIXED INSTALLATION

PLANETARIUM BERLIN / GERMANY

INSTALLED TECHNOLOGY:

- » 7 x LightCube 860 LD low noise
- » Titan laser controller
- » Light controller and control cabinets

The high intensity and good visibility of laser projections allow long distance advertising applications as well as classic billboard advertising. The visual impact of a laser advertising display is much higher than classical advertising, especially at nighttime.

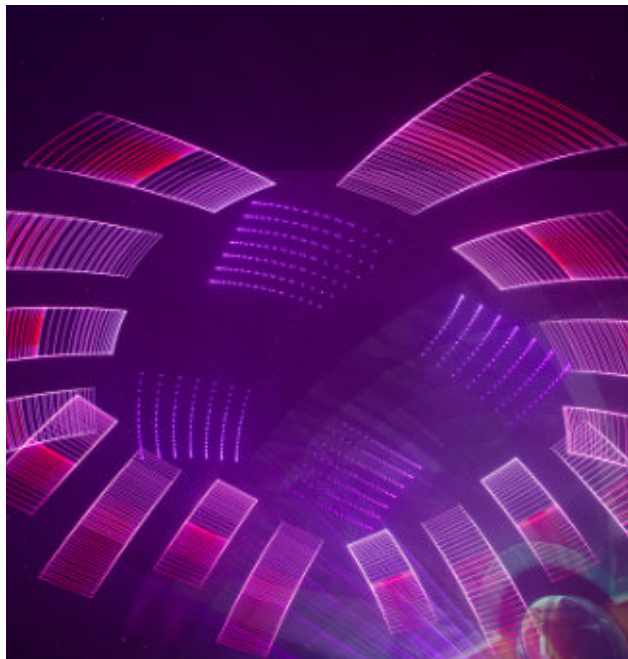
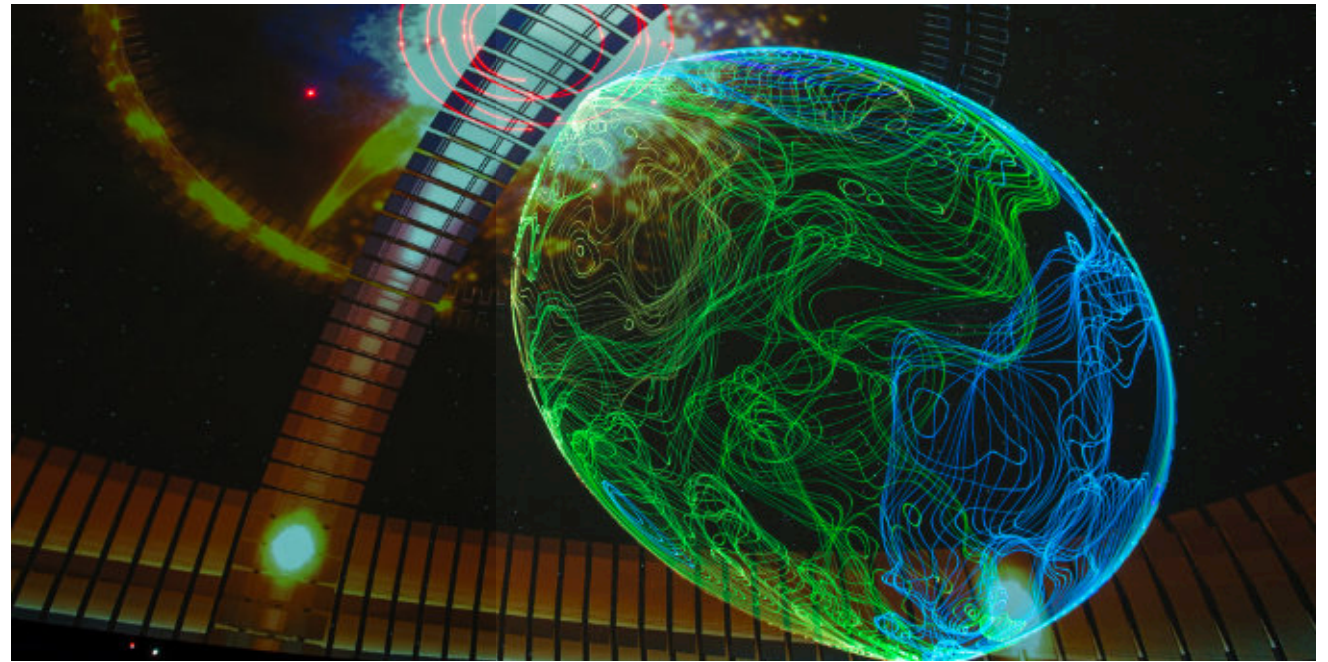

**FIXED
INSTALLATION
CAVES &
SALT MINES**



CAVES AND SALT MINES – FIXED INSTALLATION

VISITOR MINE – BERCHTESGADEN / GERMANY

HB-Laser is the specialist for difficult environments, with many years of experience in underground installations.

Custom-made devices of HB-Laser can resist these extreme environments and they are very reliable for many years. Even at daily use in aggressive environments, the sensitive equipment is perfectly protected. This more than justifies the additional expense of custom-made devices.

Examples are the salt mine Berchtesgaden and the salt mine Heilbronn as well as mine Merkers in Germany.

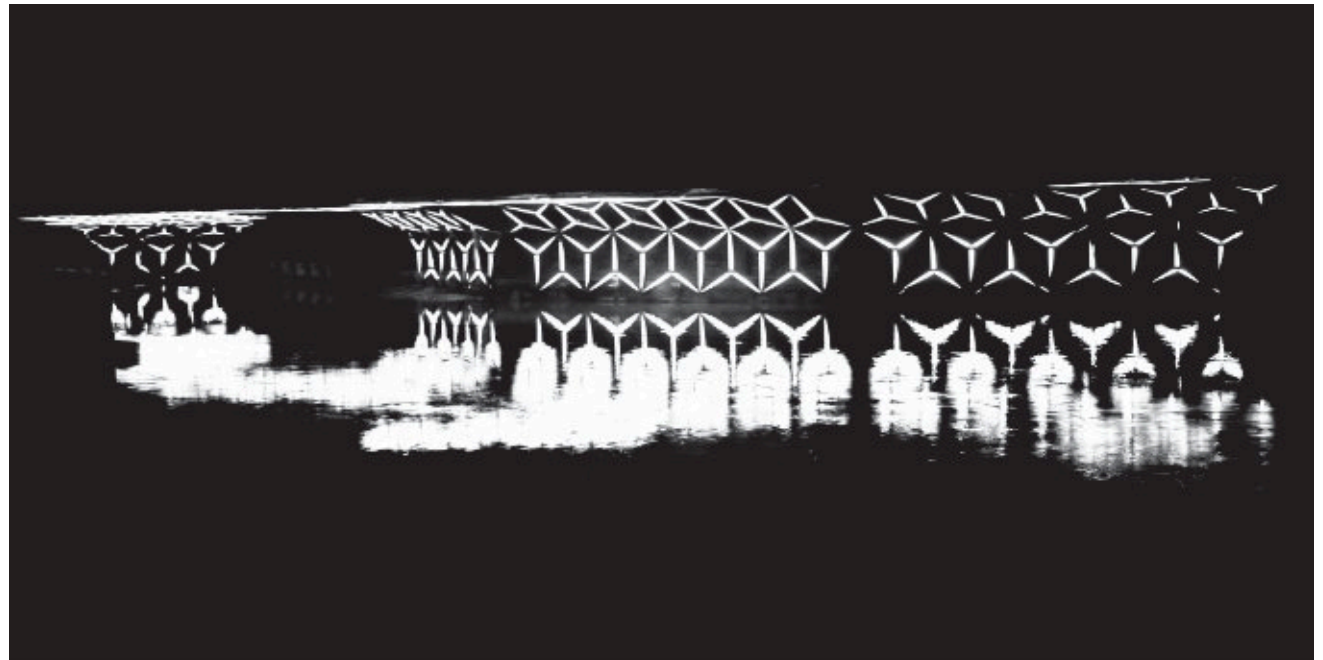

CAVES AND SALT MINES – FIXED INSTALLATION

VISITOR MINE – BERCHTESGADEN / GERMANY

Turnkey solutions illustrate what many museums expect from their multimedia partners. HB-Laser often proved their experience in not only doing spectacular laser and video installations for museums, but also providing furniture, interactive areas or the individual creation of themed rooms or areas.

Many different applications with laser, video, water or other effects can be combined to illustrate history, stories or any scientific topic. The development of ‚Edutainment‘ systems are one of HB-Laser’s core competences.

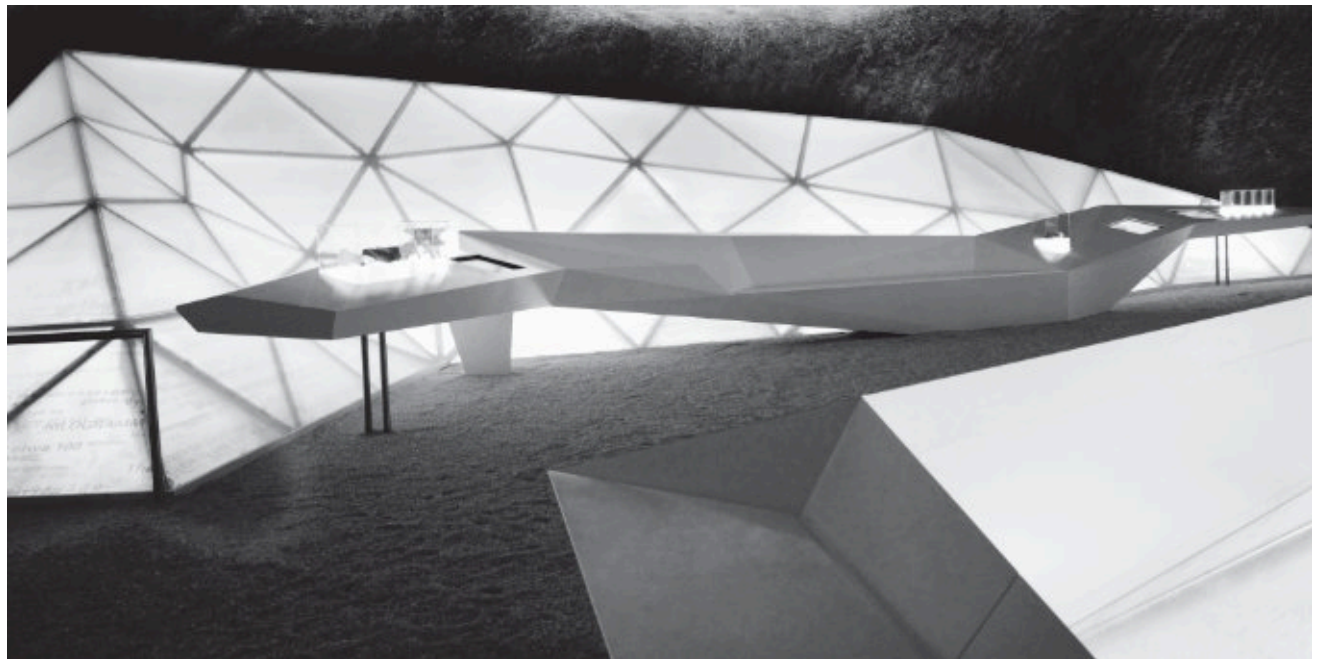
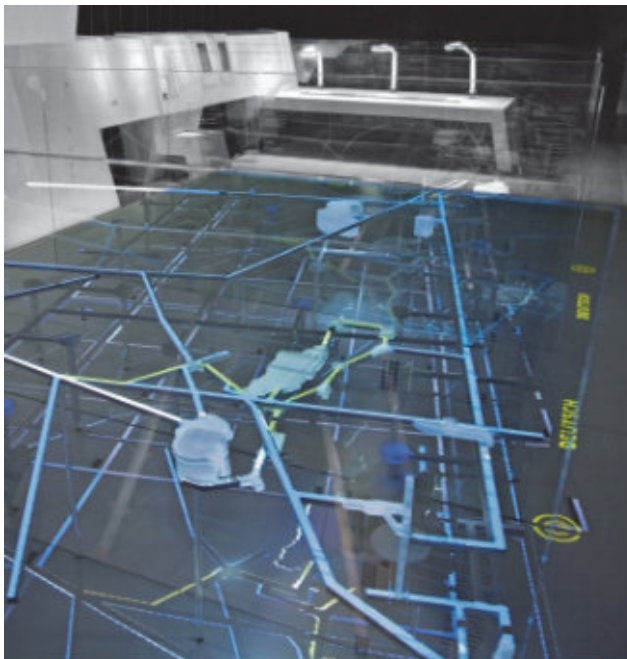

CAVES AND SALT MINES – FIXED INSTALLATION

VISITOR MINE, TIEFER STOLLEN – AALEN / GERMANY

Within this project HB-Laser was responsible for all exhibition showcases, lighting, the projection technology, sound systems, 3D models, reproductions of historical tools and rock scenery up to the special effects, such as the show blasting.

In cooperation with ATELIER STURM, HB-Laser developed the technical solution for the underground installation.

The special challenges here included show blasting and video installations in an extremely humid environment. Due to the high air humidity, the complete equipment had to be custom-made according to IP68 standard.

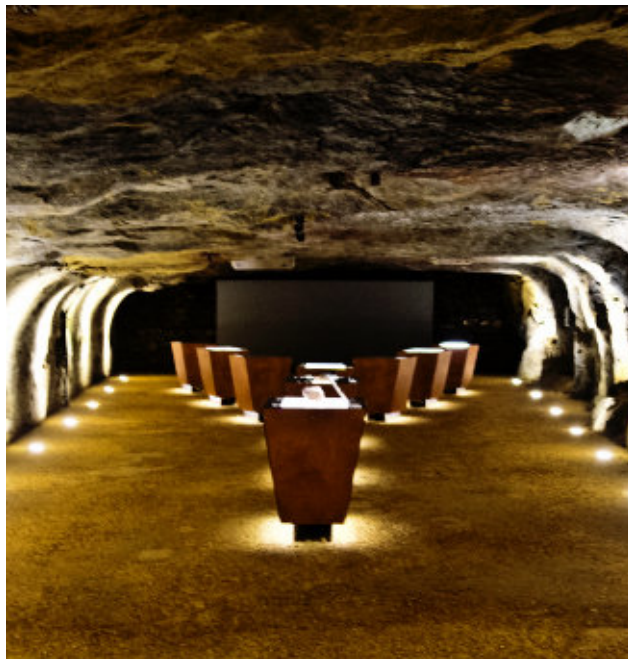

FIXED
INSTALLATION
LARGEST ASIAN CAVE
TENG LONG, HUBEI / CHINA

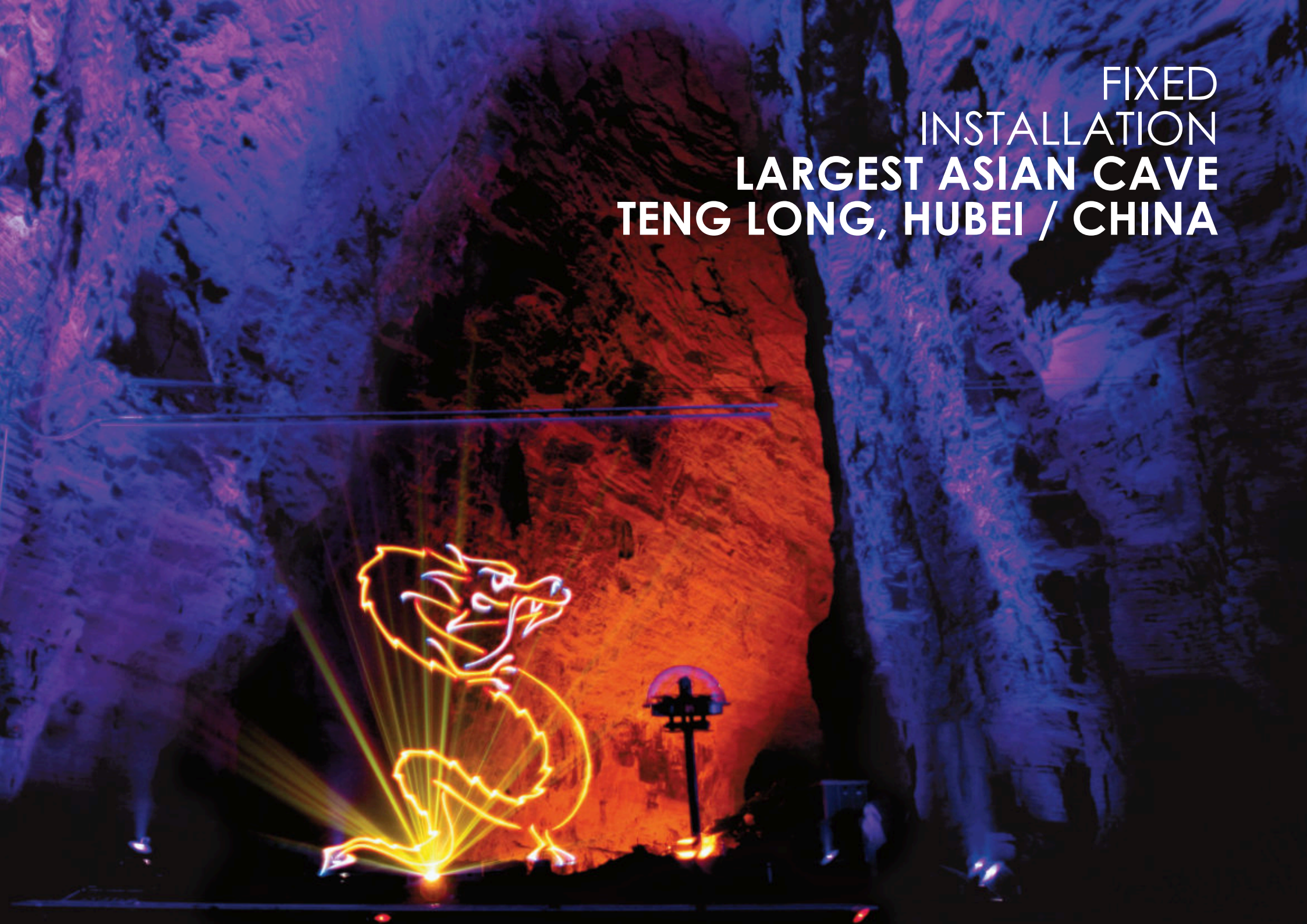

TENG LONG CAVE – FIXED INSTALLATION

INSTALLED TECHNOLOGY:

- » 5 x LightCube IP68
- » 2 x IP 68 video projector
- » 30 x RGB washlights
- » 20m Poseidon HydroScreen
- » 2 x IP 68 PinScan
- » 10 KW surround sound
- » 22 x Fog & Haze

Turnkey installation, controlled centrally by HB-TITAN controllers.

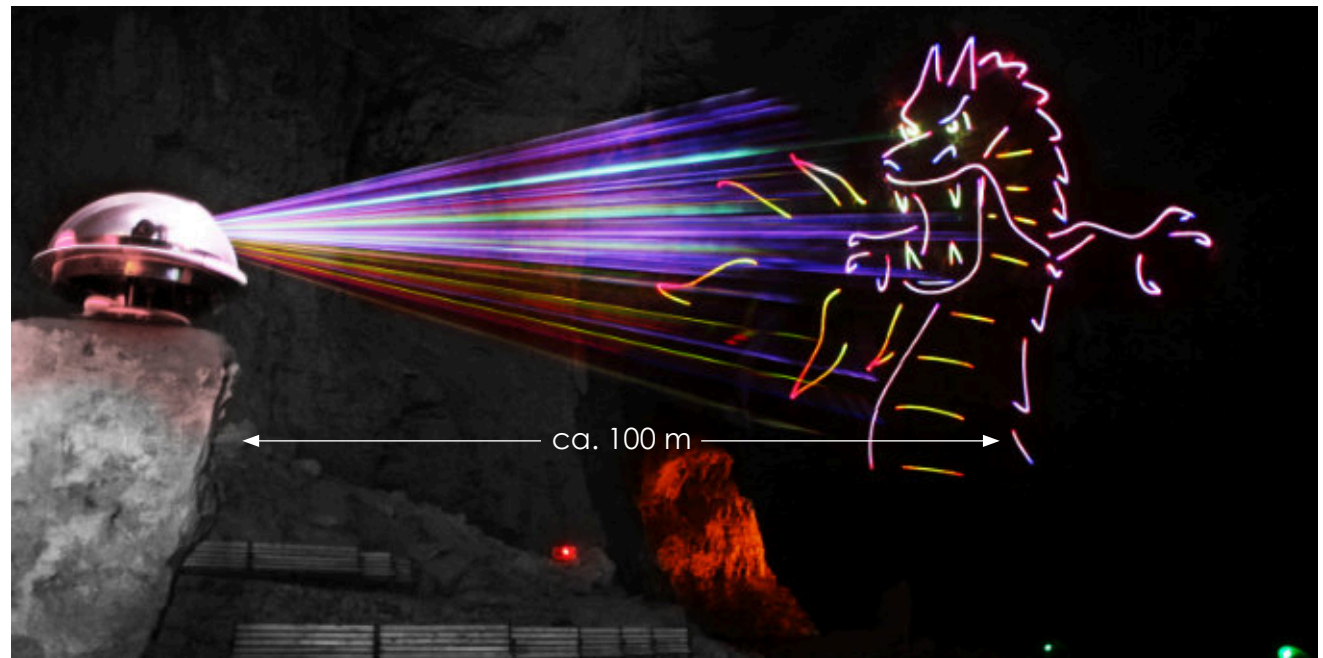



**FIXED
INSTALLATION
AMUSEMENT PARKS
HEIDEPARK / GERMANY & MIRABILANDIA / ITALY**

AMUSEMENT PARKS – FIXED INSTALLATION

Amusement parks require high quality, long-lasting laser and multimedia equipment that can be integrated into rides (roller coasters, water slides, etc.) or function as an attraction on its own.

HB-Laser installed different types of laser, multimedia shows and effects in amusement parks all around the world.

The combination of video, laser, water and pyrotechnical effects creates emotional and breathtaking effects and is a great enhancement or a supplement to the attractions, which pays off by increasing numbers of visitors.



THEME RESORT MIRABILANDIA – RAVENNA / ITALY

INSTALLED TECHNOLOGY:

- » LightCube Laser Systems
- » Video projector
- » Neptune HydroShield
- » Hazers & fog machines
- » Moving heads

Overall conception, planning and realization of a complete multimedia installation. Creation of an outdoor multimedia night show at the park lake with a size of 3,000 m² and a stand for more than 3,000 visitors.



HEIDE PARK – SOLTAU / GERMANY

INSTALLED TECHNOLOGY:

- » LightCube Laser Systems
- » High performance hazer
- » Video projector
- » Neptune HydroShield
- » Multimedia control station

Planning, show designing, programming, and installation of a big laser show and multimedia show at the park lake including a Neptune HydroShield as projection surface.



FIXED
INSTALLATIONS
**CRUISE
SHIPS**



CRUISE SHIPS – FIXED INSTALLATION

Salt water spray in the air or simply the high humidity make laser and multimedia show installations on cruise ships a challenge. These projects require the correct high-end professional equipment to withstand the environmental impacts not to forget the continuous vibrations from the engines.

HB-Laser completed several laser and multimedia show installations of Costa Crociere cruise ships:

- » Pacifica
- » Luminosa
- » Deliziosa
- » Favolosa
- » Fascinosa





FIXED
INSTALLATIONS
**CLUBS &
DISCOTHEQUES**

CLUBS & DISCOTHEQUES – FIXED INSTALLATIONS

Laser shows in nightclubs are probably the most common laser show applications.

However, there is a difference between just attaching a laser to the truss and letting it run and creating spectacular, emotional laser and lighting scenarios and effects.

HB-Laser are experts for laser installations in nightclubs and discotheques and has more than 34 years of experience in creating affordable, safe and very spectacular nightclub show installations.



KINKI PALACE – SINSHEIM / GERMANY

INSTALLED TECHNOLOGY:

- » 1 x LightCube 863
- » 2 x LightCube 860
- » 4 x LightCube 840

Spread across 2 areas, our LightCube laser systems fascinate the guests in the Kinki Palace.

For more than 10 years all LightCube laser systems have been in daily operation and there have been no problems up to now.

DISCOTHEQUE INDEX – SCHUETTORF / GERMANY

INSTALLED TECHNOLOGY:

- » 6 LightCube Laser Systems
- » 1 x Titan 5 controller
- » Fog machines and hazers

After a first laser installation by HB-Laser in 2002 the owners of the discotheque asked HB-Laser to upgrade the laser systems with more modern devices.

EVENT
INSTALLATION
**OUTDOOR &
INDOOR**



CORPORATE SHOWS – OUTDOOR INSTALLATION

Corporate Shows require maximum precision, best color fidelity and a strict adherence to the respective corporate identity.

Whether it is the launch of a new product, building and equipping an exhibition stand with multimedia, or high profile brand representation – HB-Laser has the ideas, the know-how, the technological equipment and the experienced staff needed to create spectacular corporate shows or laser show displays.



GEOVOL, UNTERFÖHRUNG GMBH – GERMANY

INSTALLED TECHNOLOGY:

- » 3 x LightCube 863 RGB 13W
- » 2 x LightCube 860 RGB 3.5W
- » TITAN multi media controller
- » Hazers & fog machines

GEOVOL has celebrated their successful drilling with a colorful laser show, logo and text projections. HB-Laser installed the show lasers and used strong hazers and fog machines to draw attention to the laser beams.

ACCRA GHANA COMMERCIAL BANK – ACCRA / GHANA

INSTALLED TECHNOLOGY:

- » 1 x LightCube LC-863 RGB 7
- » 2 x RTI FEMTO RGB 7
- » 2 x RTI NANO AT 6 RYGC35

HB-Laser implemented a corporate laser show on the occasion the reveal of the new logo reveal of the new logo of the Ghana Commercial Bank in Accra. The whole show was programmed to customer's specifications within only 10 days.

OUTDOOR SHOWS – EVENT INSTALLATIONS

Video or laser mapping describe projections towards surfaces which change their appearance using only light.

With video mapping it is possible to change the facade of a building to a completely different look. With laser mapping it is possible to create additional outlining effects, drawings, or structures. The combination of video and laser mapping creates completely new, three-dimensional effects and visual impressions.

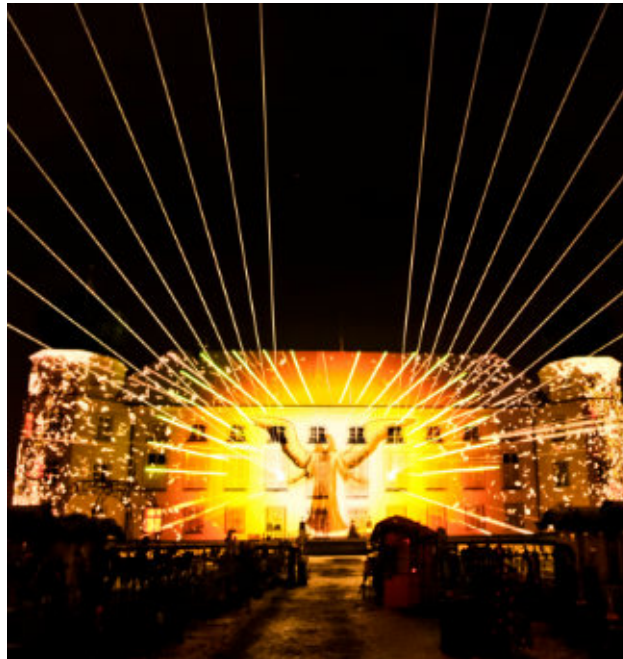

TUESSLING CASTLE – TUESSLING / GERMANY

INSTALLED TECHNOLOGY:

- » 2 x Video projectors
- » 2 x LightCube Laser systems
- » 1 x TITAN control station

Conception of the annual Christmas market show which is focused on video projection mapping. HB-Laser fascinated the audience and created spectacular 3-dimensional and colorful effects, projected at the facade of the castle Tuessling.



BILDUNGSCAMPUS HEILBRONN / GERMANY

INSTALLED TECHNOLOGY:

- » 2 x Video projectors
- » 6 x LightCube laser systems
- » 1 x TITAN control station
- » 1 x TITAN video mapping station

HB-Laser created a video and laser mapping show for the opening of a new part of the university. The facade was covered with 3D video animations, mapping and outlining effects.



OUTDOOR SHOWS – EVENT INSTALLATIONS

The advantage of lasers over conventional lighting is the superb precision of the light beam. A laser beam expands only very slightly, in contrast to conventional light, and is therefore ideally suited for projections over long distance.

HB-Laser has been successfully putting customer wishes into the right light for decades. Whether large laser projections on mountains, sights visible over more than 30 km or 360° projections on ceilings, floors or laser mapping on facades at trade fairs and events. HB-Laser offer unique solutions.

With the special LightCube high-end laser systems outdoor laser effects can be created which are visible as far as 30 km away and even beyond.



SCHAERDING / GERMANY

INSTALLED TECHNOLOGY:

- » 6 x Video projectors
- » 2 x TITAN control stations
- » 30 x LED architectural floodlights

HB-Laser was responsible for the whole project and installed a fixed multimedia outdoor installation to illuminate specific parts of the cities of Schaerding and Neuhaus with video mapping and projections onto facades.

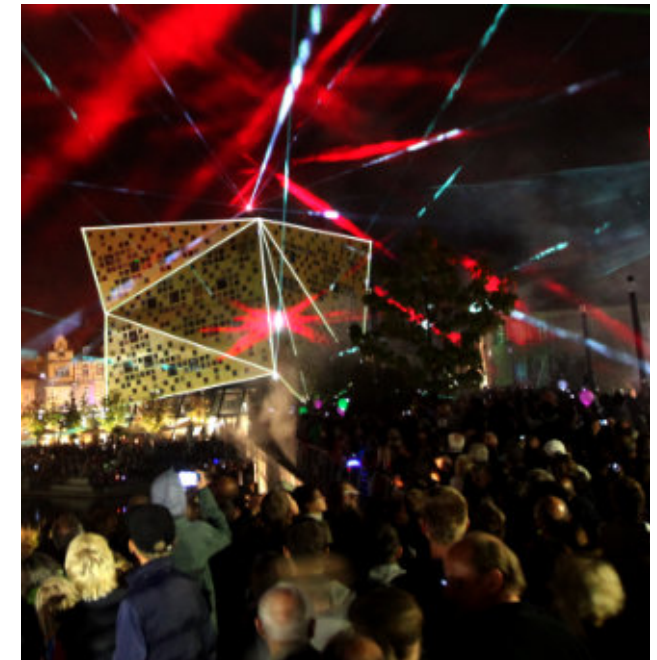

STATE HORTICULTURAL SHOW – SCHW. GMUEND / GER

INSTALLED TECHNOLOGY:

- » 6 x LightCube Laser Systems
- » 1 x TITAN control station
- » several fog machines
- » incl. sound system
- » 15 x LED bars

Massive laser multimedia show with laser mapping on a central building of Schwaebisch Gmuend. The show was a major highlight of the horticultural show.



FESTIVALS & CONCERTS – EVENT INSTALLATIONS

More and more festivals happen every year, concerts become more popular and many stage shows take place every summer.

Lasers are a great addition to any type of show – no matter if it's an electronic music festival, a rock & metal festival, stage shows or classical concerts. A laser show underlines the music in a special way. They emotionalize the spectators and make them „feel“ the music much more intensely.



ANDY LAU „UNFORGETTABLE TOUR“ – ASIA TOUR

INSTALLED TECHNOLOGY:

- » 8 x LightCube Laser Systems
- » 2 x Stage mirror systems for artist performances
- » TITAN multimedia controller

The HB-Laser systems were used throughout the Andy Lau Asia concert tour. The laser systems were used to create a cage-like laser beam effect and graphics projections.

MASTERS OF HARDCORE – S´HERTOGENBUSCH / NED

INSTALLED TECHNOLOGY:

- » 32 x Different high power laser systems
- » DSP control systems
- » GrandMA2s

25,000 people attended the hard dance electronic music event 'Masters of Hardcore'. A long-term partner did the laser show performance and used this stupendous show laser setup.

IAA MERCEDES BENZ – 360° LASER MAPPING

For Mercedes Benz, HB-Laser mapped the complete organic ceiling structure (5.500 m²) in hall 1 with only 4 laser projectors at the IAA exhibition. Dynamic and unprecedented possibilities were realized in connection with video mapping in the ceiling projection.



REALIZATION
OF
AN
EVENT



REALIZATION OF AN EVENT

HB-Laser has an in-house creative team of designers, technicians and engineers realizing individual and memorable events according to customers' wishes.

We offer turnkey solutions starting with an idea and the resulting conception, planning, production and implementation. The final event is a perfect harmony of technology and emotions.

Our own multimedia studio offers withing 400 sqm all possibilities to realize the customer's wishes. In these studios laser, light, water, fire, video, fog, and sound systems are always available. Thus an easy and cost effective production is given.

In addition to conception and production HB-Laser offers further services, such as transport, customs clearance, setup and personal attendance on site.

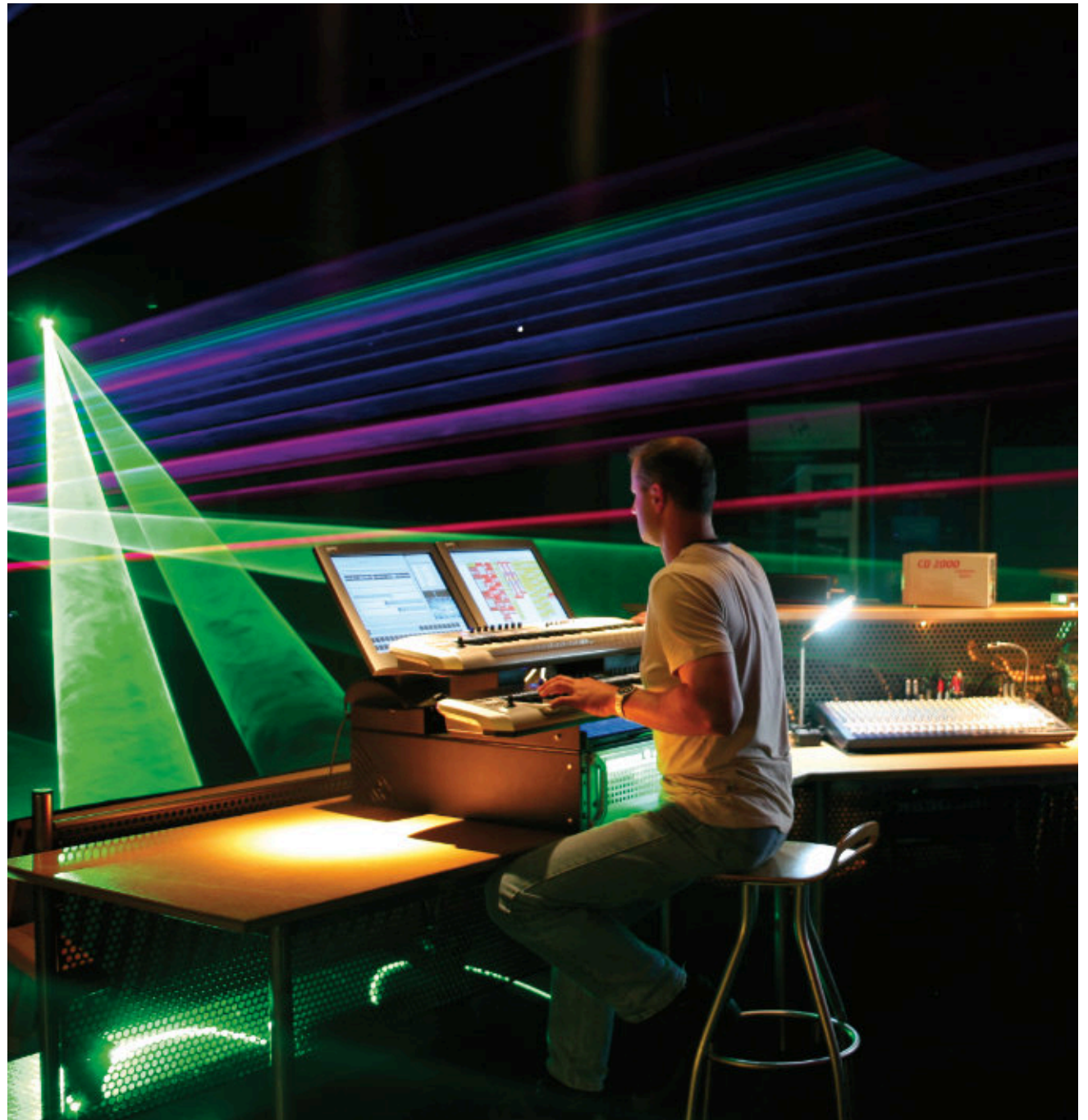

HB-LASER



GERMANY

**EXCELLENCE
IN LASER
& MEDIA
TECHNOLOGY**



CUSTOMIZED LASER SOLUTIONS

Top quality lasers with well thought-out concepts, tailored to the respective requirement. For fixed installations, lasershows and rental.

WHO WE ARE

HB-LASER ON SITE

HB-Laser's operational areas and services focus not only on its headquarters in Germany but extend to locations all around the world.

At the location in Schwaebisch Gmuend the departments for development, production, project planning, designing, training as well as the creative department are housed. On site our teams take care of implementation and realization of projects.

Sometimes the operational areas couldn't be more different: whether indoors or outdoors, in areas with extreme (weather) conditions, on buildings, underwater, or in underground tunnels – HB-Laser has many years of experience and competent, highly qualified staff to implement projects so that customer's expectations are exceeded.

In addition to the project implementation, technical modifications, maintenance and service on site are also parts of the service spectrum of HB-Laser.

HB-LASER SHOW LASER SYSTEMS

Since 1990 HB-Laser manufactures show laser light projection systems. No matter what size or complexity a project is – HB-Laser has the suitable product for it.

Waterproof lasers are available as well as lasers especially tuned for advanced graphics capability. Power ranges from around 1W RGB to more than 150W - or even more!

In comparison to others HB-Laser is able to build up customized show lasers and/or according to project-specific requirements. Thus it is possible to create an optimal initial situation for every project.

www.hb-laser.com

OUR
COMPETENCIES
SERVICE
& SUPPORT



WHO WE ARE

COMPETENCIES

HB-Laser offers a wide range of products and services to provide comprehensive solutions to our customers. Besides DPSS, diode and OPSL laser systems, event services are also part of the solution. Each event is individual, dynamic and emotionally designed and realized - independent of the size.

For the multimedia sector reactive projection systems can be offered as well as interactive and customized solutions. Impressive fountains can integrate the element of water into the show. Software and sound solutions round off the product portfolio. HB-Laser provides the opportunity for industrial and B2B customers to find a comprehensive range of industrial laser systems, components and OEM products.

SERVICE & SUPPORT

HB-Laser specializes in offering to its customers a wide range of products and services for the show, event and entertainment industry.

THIS INCLUDES:

- » Project planning
- » Turnkey solutions
- » Show production
- » Laser systems
- » Multimedia technology
- » Research and development
- » Customer training
- » Laser safety training
- » Installations
- » Rental services
- » Event planning
- » Event services



OUR
CUSTOMIZED
LIGHTCUBE
SERIES



OUR LASER PERFORMANCE

Since 1990, HB-Laser has been gaining experience as an important laser show company in show production, laser installations, multi media projects and show laser light manufacturing.

Product innovation and product quality as well as the high professional planning, designing and implementing of any kind of multimedia show application made HB-Laser a worldwide known brand in the show laser industry.

Professionalism and quality of work generating long term partnerships all around the world as well as the strong support by affiliates within the company group allow HB-Laser to react to customer demands worldwide on short notice.

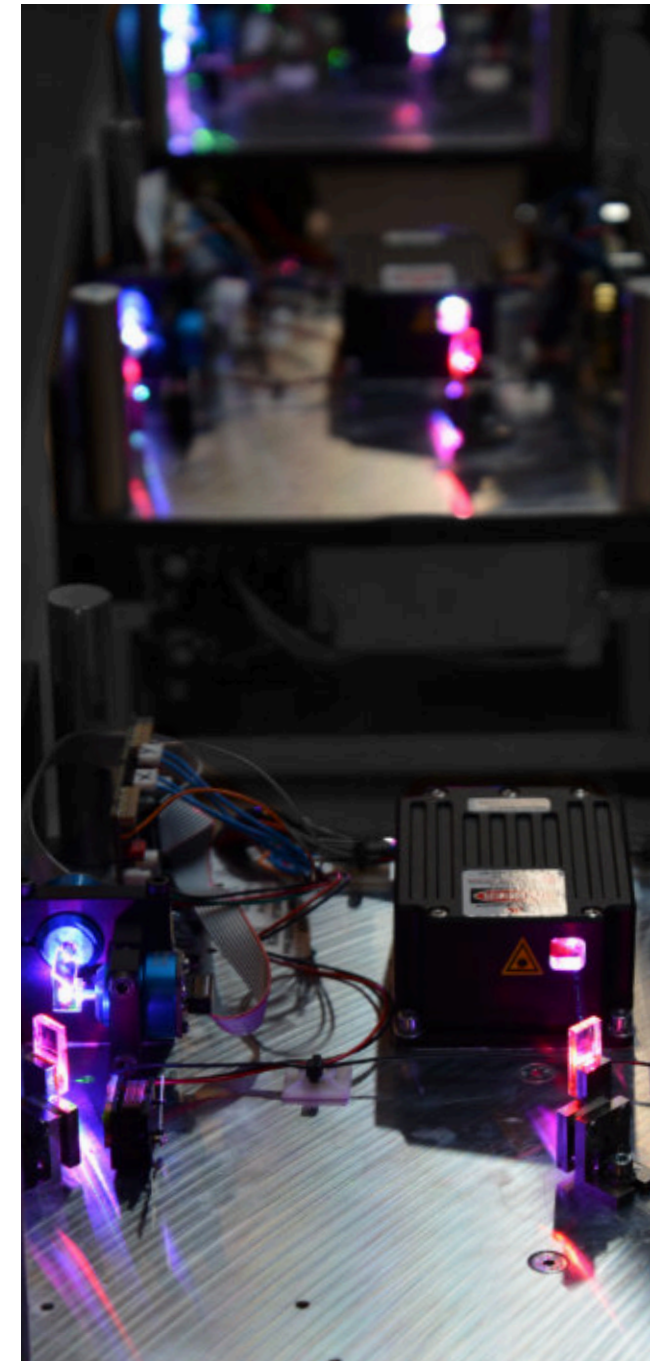

LIGHTCUBE UNIVERSAL 841



A compact show laser series in a robust, dust and weatherproof IP 53 housing. Developed and manufactured in Germany it is a perfect match for high-quality show laser applications, in- and outdoor.

- » Air-cooled
- » Dust- and weatherproof housing provides maintenance-free systems
- » Extremely quiet operation makes this series a must have for museums, theatres and planetariums

The RGB white light show lasers are equipped with Pure Diode Technology, offering superior beam characteristics, modulation and linear color transition. Fast Apollo Max scanners allow scanning angles up to 80° and scanning speeds up to 45kpps @ 8° (optional up to 60kpps @ 8°). The HB-FB-4 controller is equipped with a colored display and controls all options, such as color balance, geometric corrections and safety settings. It offers standalone operation with time switch, ILDA in/through and LAN connection.



* **Optionally** a DMX control is available.

* **TECHNICAL DETAILS ON REQUEST**

 Rock-solid design	 ECO Energy saving technology	 > 10 000 hours Long lifetime	 Active RGB linearization	 450 nm 520 nm 638 nm Pure White Best color gamut 450 to 638 nm
 IP 53 For outdoor use	 Maintenance free	 Pure Diode Pure Diode technology	 +R +G +B Digital color balance	 Direct access to geometric picture correction
 24V Safe operation in water	 TCP IP Network	 Dynamic zone safety	 ESD protected, stabilized switching power supplies	 CPU up to 8 Microprocessor controlled
 80k pps High speed scanning up to 80.000 pps	 ILDA standard in-out-through	 DMX	 TEC-Active air-cooling technology	 -20 °C +50 °C Wide temperature range for outdoor

LIGHTCUBE PROFESSIONAL 860 MKII



The RGB white light show lasers are equipped with Pure Diode Technology, offering superior beam characteristics, modulation and linear color transition. Fast Apollo Max scanners allow scanning angles up to 80° and scanning speeds up to 45kpps @ 8° (optional up to 90kpps @ 8°). The HB-FB-4 controller, is equipped with a colored display and controls all options such as color balance, geometric corrections and safety settings. It offers standalone operation with time switch, ILDA in/through and LAN connection.

* **Optionally** DMX operation and an integrated GB switch for easy connect via the LAN signal available.

A compact show laser in a robust and dustproof housing. Developed and manufactured in Germany it is a perfect match for high-quality show laser applications.

- » Unique Shock-Absorbing-Technology minimalizes influences caused by vibrations, shocks or bumps. It prevents damages/misalignment of the optical parts. (great for touring and rental)
- » Processor-controlled, active temperature regulation ensures a long lifetime even if the system is continuously operated
- » Dust proof housing provides maintenance-free systems
- » Extremely quiet operation makes this series a must have for museums, theatres and planetariums



* TECHNICAL DETAILS ON REQUEST



Rock-solid design



ECO Mode
Energy saving technology



Long lifetime



Active RGB linearization



Pure White
Best color gamut
450 to 638 nm



Shock absorbing technology



For outdoor use



Maintenance free



Pure Diode technology



Digital color balance



Direct access to geometric picture correction



Safe operation in water



TCP/IP Network



Dynamic zone safety



ESD protected, stabilized switching power supplies



Microprocessor controlled



High speed scanning up to 80.000 pps



ILDA standard in-out-through



DMX



TEC-Active air-cooling technology



Wide temperature range for outdoor

LIGHTCUBE PROFESSIONAL 863 MKII









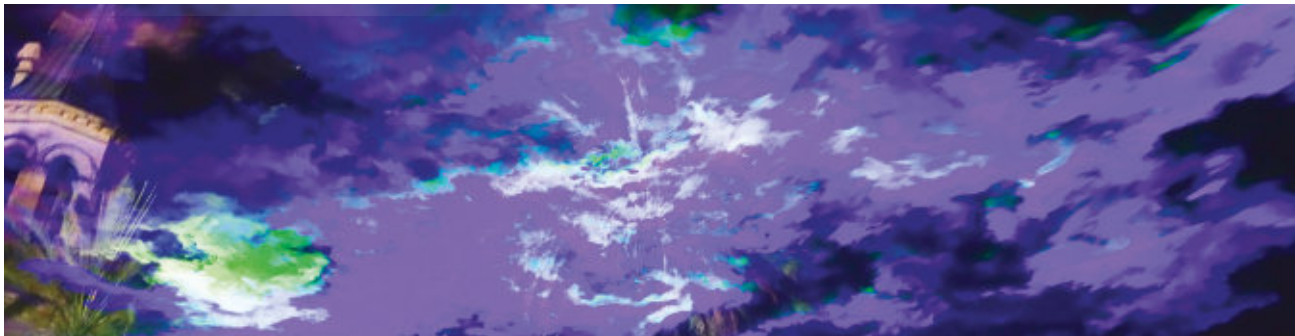













A compact show laser series in a robust and dustproof housing. Developed and manufactured in Germany it is a perfect match for high-quality show laser applications.

LightCube Professional series is manufactured individually and can be adapted to customer requirements. Achievements up to 300W RGB and Low Divergence Executions with OPSL or fiber laser technology are available on request.

With integrated HB-FB4 controller are all connection options integrated. SD card player, TCP / IP, ILDA, DMX allows easy implementation in multimedia environments.



*** TECHNICAL DETAILS ON REQUEST**

- | | | | | | |
|---|--|---|--|---|--|
|  Rock-solid design |  ECO Mode
Energy saving technology |  > 10 000 hours
Long lifetime |  Active RGB linearization |  450 ^{nm}
520 ^{nm}
638 ^{nm} Pure White
Best color gamut
450 to 638 nm |  Shock absorbing technology |
|  IP 53
For outdoor use |  Maintenance free |  Pure Diode
Pure Diode technology |  +R
+G
+B
Digital color balance |  Direct access to geometric picture correction | |
|  24V
Safe operation in water |  TCP IP Network |  Dynamic zone safety |  ESD protected, stabilized switching power supplies |  CPU
up to 8
Microprocessor controlled | |
|  80 ^k pps
High speed scanning up to 80.000 pps |  ILDA standard in-out-through |  DMX |  TEC-Active air-cooling technology |  -20 ^{°C}
+50 ^{°C}
Wide temperature range for outdoor | |

LIGHTCUBE PROFESSIONAL 851 IP68 WATER & WEATHERPROOF

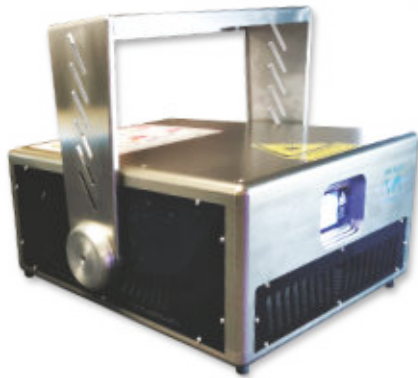

LightCube 851 IP68 – a compact show laser series in a weather- and waterproof aluminium housing. Developed and manufactured in Germany it is a perfect match for high-quality show laser applications in aggressive and damp environments – Permanent installations in baths, caves, mines and musical fountains.

- » Processor-controlled, active temperature regulation ensures a long lifetime even if the system is continuously operated
 - » The housing is waterproof rated IP68, with integrated heating, which makes the systems maintenance-free also under challenging weather conditions
- The RGB white light show lasers are equipped with Pure

Diode Technology, offering superior beam characteristics, modulation and linear color transition. Fast Apollo Max scanners allow scanning angles up to 80° and scanning speeds up to 45kpps @ 8° (optional up to 60kpps @ 8°).

* **Optionally** an integrated HB-FB-4 controller with standalone operation with time switch, ILDA in/through and LAN connection is available. DMX control is also available.



* TECHNICAL DETAILS ON REQUEST

 <p>Rock-solid design</p>	 <p>ECO Mode Energy saving technology</p>	 <p>> 10 000 hours Long lifetime</p>	 <p>Active RGB linearization</p>	 <p>Pure White Best color gamut 450 to 638 nm</p>
 <p>For outdoor use</p>	 <p>Maintenance free</p>	 <p>Pure Diode technology</p>	 <p>Digital color balance</p>	 <p>Direct access to geometric picture correction</p>
 <p>Safe operation in water</p>	 <p>TCP IP Network</p>	 <p>Dynamic zone safety</p>	 <p>ESD protected, stabilized switching power supplies</p>	 <p>Microprocessor controlled</p>
 <p>High speed scanning up to 80.000 pps</p>	 <p>ILDA standard in-out-through</p>	 <p>DMX</p>	 <p>TEC-Active air-cooling technology</p>	 <p>Wide temperature range for outdoor</p>

HB-LASER LIGHTCUBE 360°



SPECIFICATIONS:

- » 360° projection lens
- » Projection radially around the center system
- » Usable with different show laser systems with up to 20W power
- » Vertical scan angle: ca. 90°
- » Horizontal scan angle: 360°
- » Scan speed up to 90kpps

* TECHNICAL DETAILS ON REQUEST

HB-LASER LIGHTCUBE 863 OPSL HIGH END

SPECIFICATIONS:

- » Shock-Absorbing Technology preventing misalignment
- » Intelligent dynamic zone safety- setting at back side
- » Up to 30W RGB laser system with great white balance
- » OPSL technology
- » CT-6215 scanners with Apollo drivers
- » Color balancing, size, flip, rotate and offset directly adjustable at the device

* TECHNICAL DETAILS ON REQUEST

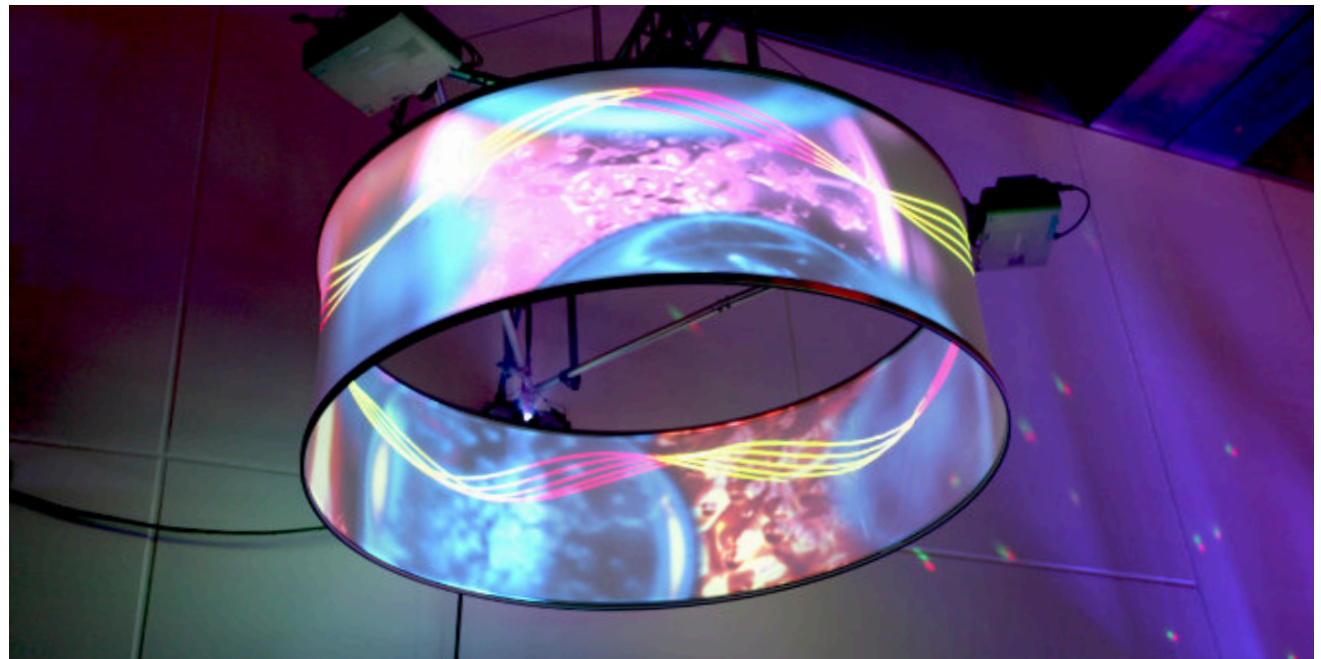

WE ARE THE EXPERTS FOR YOUR SOLUTIONS

We have the know-how, over three decades of experience and the ability to offer the appropriate and professional laser production solution for indoor and outdoor applications.

Our customized solutions in our own production are found worldwide in a wide variety of application areas:

- » Optics
- » Mechanics
- » Electronics
- » Laser systems for public use
- » Laser systems for industrial use
- » Medical applications

A CUSTOMIZED SOLUTION IS OUR PASSION.

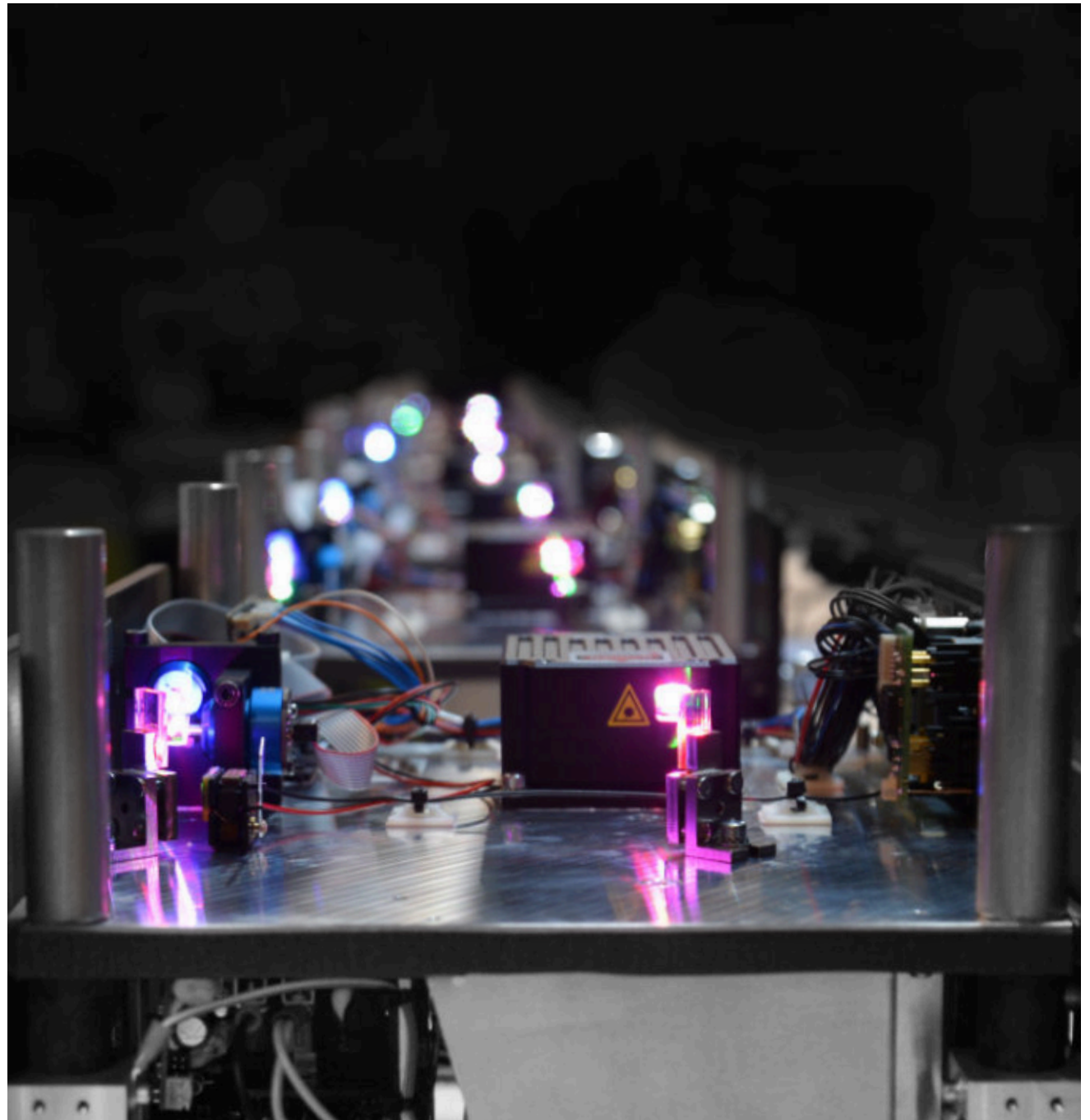

LASER ACCESSORIES
OEM PRODUCTS
CLIMATE / WEATHER PROTECTION
& PROJECTION SCREENS

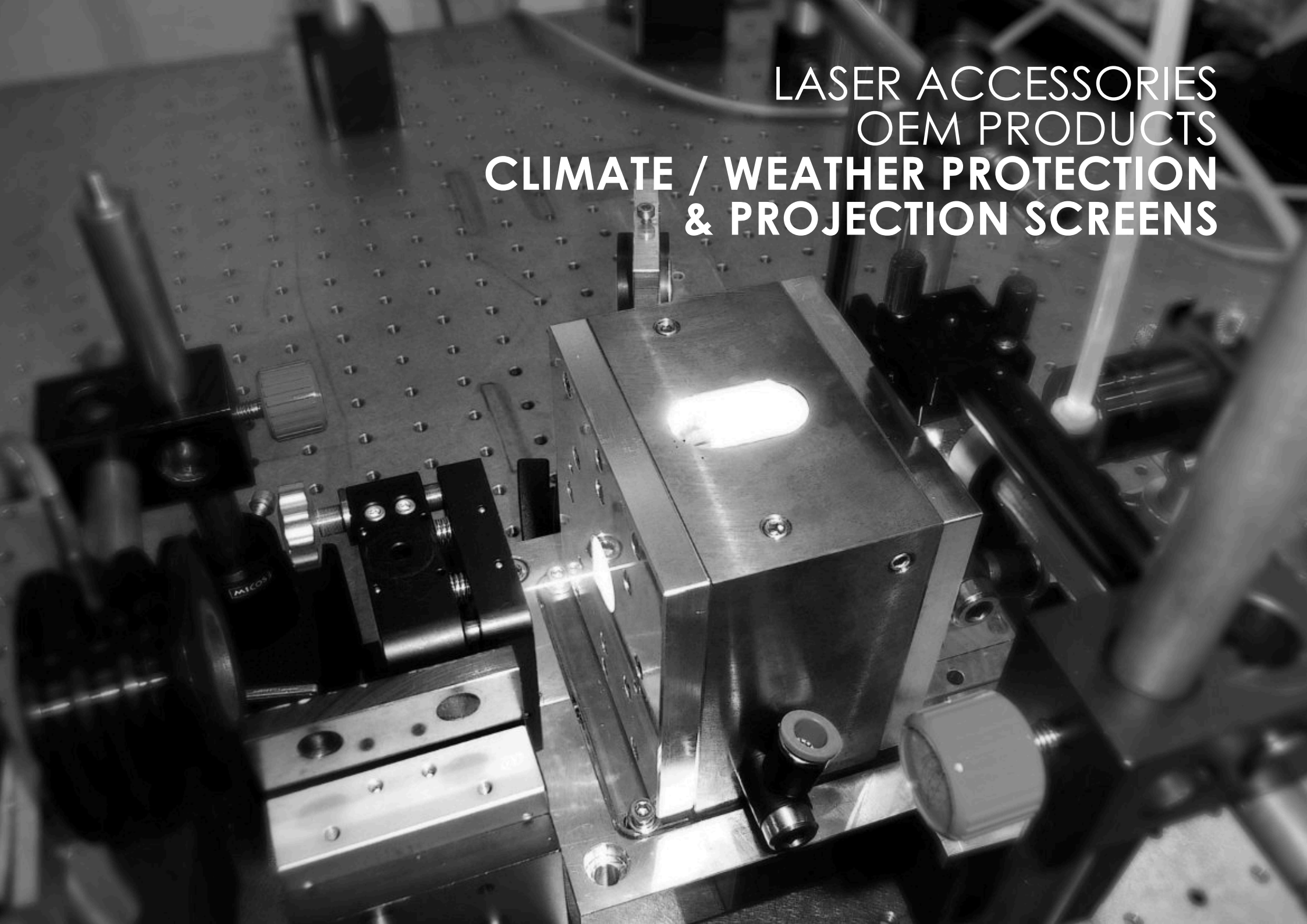

LASER ACCESSORIES

VULCAN INDUSTRIAL LASERS

HB-Laser offers a huge variety of industrial laser systems including accessories. All components are available as single pieces. OEM products and custom specific developments are available on request.

POSSIBLE PROCESSINGS OF:

- » Textile & Leather positioning
- » Wood
- » Stone, Glass & Ceramics
- » Rubber, Tyres & Plastics
- » Metal
- » Paper
- » Aircraft, Vehicle & Mould Constructions
- » Labeling
- » Measurement image processing
- » Medicine technology

OPTOMECHANICS

The HB-Laser team of engineers, with years of experience, develops CAD supported optical and mechanical systems. Factoring in the in-house CNC production, this is an assurance of highest precision and sturdiness. Regardless of which HB-Lasers' standard products, a customized components assembly or units made to customers specification – quality and life span rank first. In-house tool design and construction make quick and low-cost solutions possible even for the most eccentric special design.

OVERVIEW / ACCESSORIES

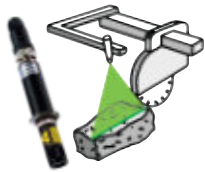

Vulcan Line Lasers

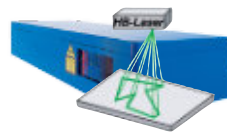

CPS CAD/
Projection Systems



Mountings



Laser Mirrors, Filter, Scanners,
Polarisation Cubes



Outdoor & Indoor
Mirror Mounts



Fine-adjustable
Mirror Mounts



Linear Laser Collimator



OEM Fibre Optic Sets



360° Scanning Optics



Interlock Box



HB-FB-4 BREAKOUTBOX FOR LASERSYSTEMS

is a network interface that is available with Pangolin Quickshow or Pangolin BEYOND. With the HB-FB-4 Break-OutBox, it is no longer necessary to connect the computer to the show laser via an ILDA interface. Control is done via network with Quickshow or BEYOND, by DMX or in stand-alone mode.

FEATURES OF THE HB-FB-4 BREAKOUTBOX:

- » Control via Ethernet cable with integrated GB-Switch for looping through signal can be used with any ILDA-compliant show laser system
- » Automatic mode via SD card, standalone operation with time switch
- » Color display
- » DMX control
- » Supports scan speeds up to 120kpps
- » 6 - color channel support
- » Improved laser output by interpolation
- » Dual ILDA out
- » Project settings
- » Network settings
- » Color settings
- » Image corrections
- » Security settings

OEM PRODUCTS

Analog and digital systems for measurement and control for high-speed and precision tools rank highly in HB-Laser's development center.

Whether customized diode driver units for medical engineering, scanning systems in the industrial sector or modules for multimedia and illumination.

HB-Laser's development and production always meet highest expectations to the limit of what is technically possible.

The in-house production enables highest flexibility and reliability. All components are available as single pieces. OEM products and customerspecific developments are possible at any time.

OVERVIEW / OEM PRODUCTS



Ares Diode Drivers



Apollo CT-6210 / 60k scanning system



Universal Media Controller / RS23 & Analog Merger



OEM Laser up to 1000W green 0,2 mrad



Apollo Infinity superfast / 3 & 6mm 80K Scanning



Apollo CT-6215HP / 3 & 6mm

CLIMATE HOUSINGS / WEATHER PROTECTION

CUSTOMIZED IP HOUSINGS

HB-Laser offers customized solutions for every environment. Mostly the technology has to be integrated as invisible as possible into the project. Standard air conditioning units cannot offer this. Therefore HB-Laser develops and builds individual solutions according to customer requirements.

Due to our decades of experience we are able to realize condensation-free air conditioning housings even in the most confined spaces. From simple rain protection to IP68 housings for underwater use, aggressive environments in mines or extreme temperature ranges from -50°C to $+60^{\circ}\text{C}$.



PROJECTION SCREENS

For projections with lasers, lights or videos HB-Laser offers motorized screens made of foils or gauze. In a breathtaking manner, dynamic front or rear projections of laser light can be created, only depending on your demand; in combination with slide- or video projection astounding multivision effects are possible. The screens have a fast tube motor with 2 m per second to enable an exact and silent run.

Details about the different materials and dimensions on request.

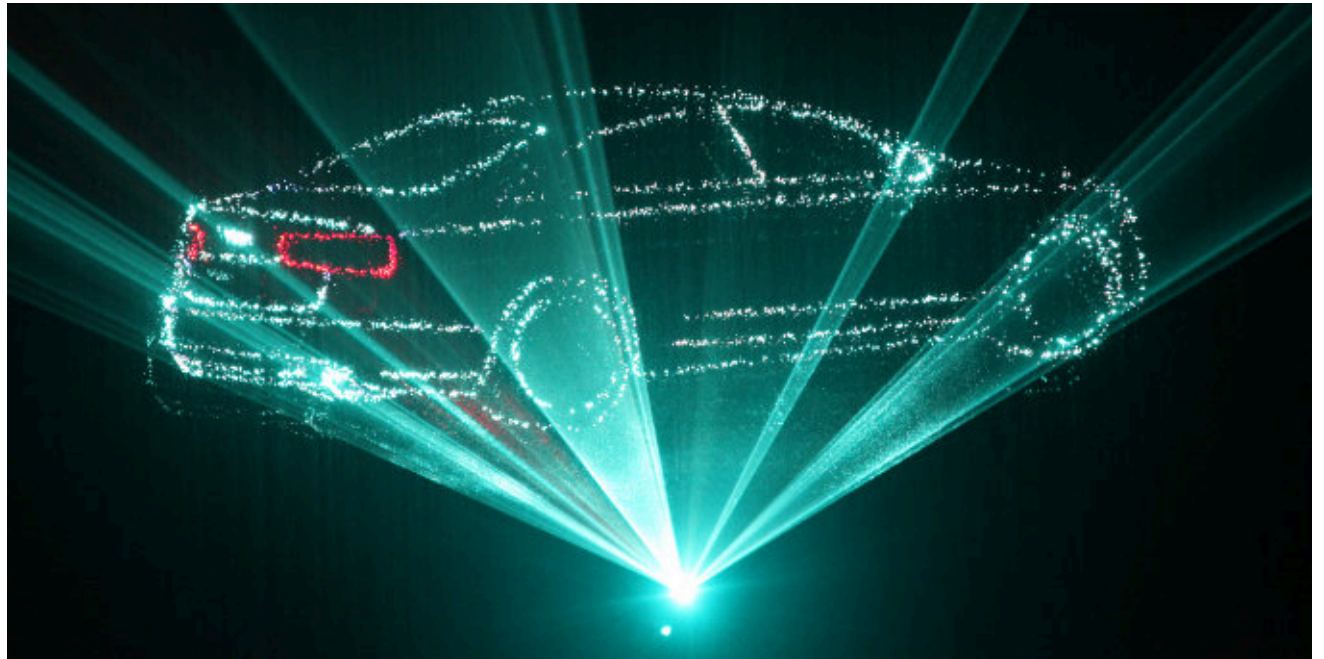

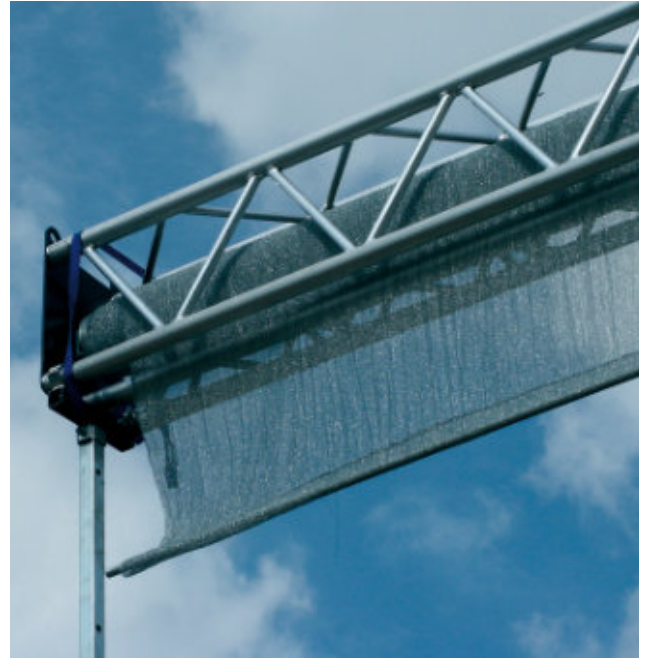

OUR
IVS/
INTERACTIVE
VISIONS



HB-LASER
GERMANY

INTERACTIVE
VISIONS





REACTIVE – MULTILAYER – VIDEO – PROJECTION SYSTEM

EXPERIENCE ADVERTISING AND SALES PROMOTION IN A PLAYFUL WAY

INTERACTIVE VISIONS® / THE CROWD PULLER!

An interactive projection system as ideal sales promotion – it is suitable for table, bar, counter, floor, wall, ceiling or shop window projections. Compact design and quick and easy assembly – also suitable for use in theaters and stages.

Any projector with a resolution up to 4k (or alternatively an LED wall) can be connected to the Interactive Visions System. 2 Full HD projectors and several systems can also be combined with each other.

Special programming enables the interface to control light and costume projections (spotlights, LED stripes, moving heads) via Artnet and DMX.

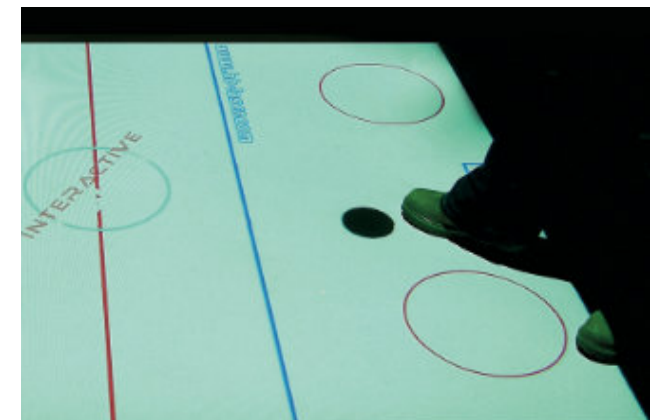
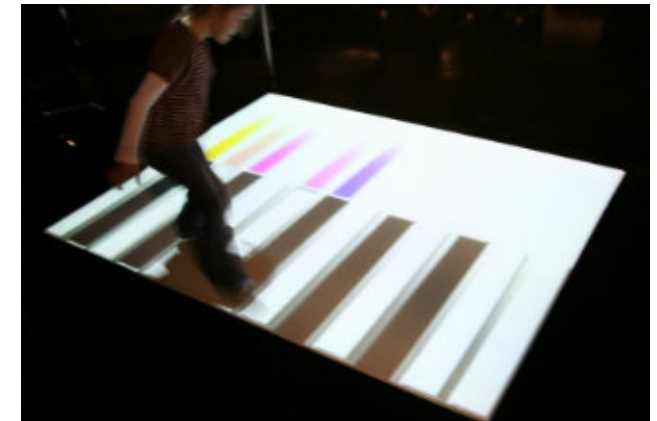
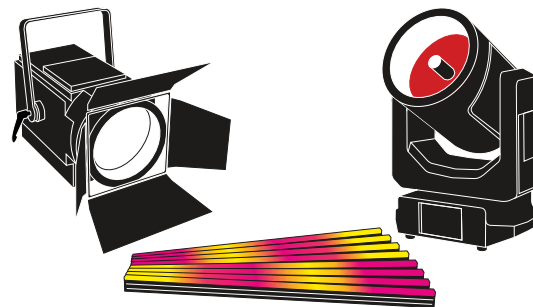

FUNCTION OF THE INTERACTIVE VISIONS

THE EXAMPLE OF "WATER AND FISH":

Fish swim in the water and react to your movement – the „water“ makes waves and a splash makes the effect an experience. Different layers are superimposed.

The water effect overlays the fish.

The fish can be placed on any background image.

You can choose any image as a background and load it into the IVS system (BMP or JPG with a resolution of the respective video projector or LED wall).

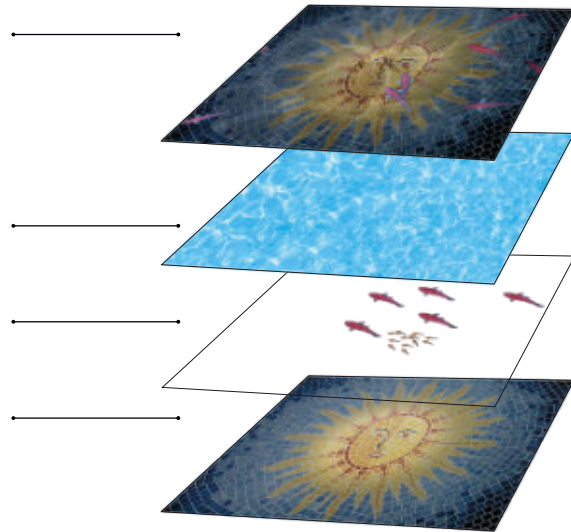

INTERACTIVE VISIONS IP HOUSING

The Interactive Visions IP System combines all components for an interactive projection in a flexible, weatherproof housing. The system can be used both indoors and outdoors thanks to a special ceiling or mast mount.

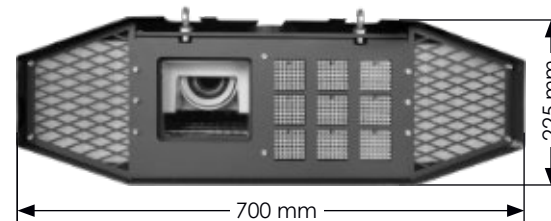

THE SYSTEM HAS THE FOLLOWING COMPONENTS:

- » Weather-resistant powder-coated IP53 housing in available RAL colors
- » Interactive Visions Professional System
- » Dedicated camera with selectable lens and bracket
- » Integrated infrared LED radiator
- » Filtered and temperature controlled cooling and heating system
- » Customized solutions for all kind of video projectors



SOME IVS EFFECTS IN PROCESS

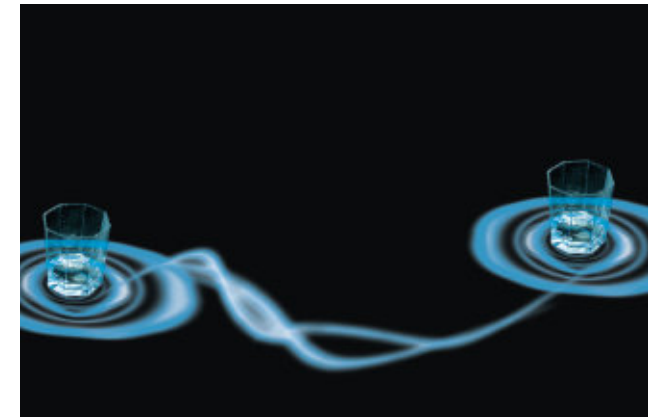

IVS EFFECT EXAMPLES

This is a small selection of 25 standard effects that you can adapt to your design - individual programming is possible on request.



Bubbles



Fluid particles

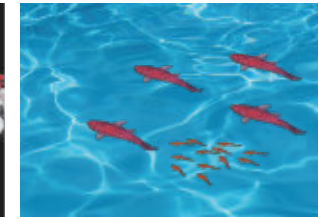

Swarm-fish



Traces plain



Fluid plasma



Combes



Particles

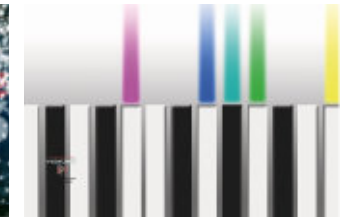

Piano

SOME REFERENCES WORLDWIDE

Mazzo Nuovo, Amsterdam Netherlands	Chutian Demo Showroom China	Submarine Belgrad Serbia	AXENTE France Demo Studio France
Bhagdadi Saudi Arabia	Viking St. Petersburg Russia	PineCreek India	Chutian Laser - Wuhan China
Xamin Teheran Iran	Wir leben - Apotheke Germany	Global Show Productions Greece	RENO Schuhe Germany
PACRIM Audio CO China	Xarrin Dubai	Axente France	BigFish Manila
Ravensburger Germany	Swedish Trade Sri Lanka	Sangalli Technologie Italy	AVL Nik Mazukes South Africa
Vitrinen und Glasbau Reier GmbH - Germany	EDEKA Hamburg Germany	Fina Tehno LED d.o.o. Serbia	Laser Projects United Kingdom
Laservisual Portugal	Laserpower Chile	Sarner United Kingdom	Au Quai Club Hamburg Germany
Quebec Leisure Singapore	LIK Service Moskau Russia	Danfoss Denmark	Sternwarte Bergedorf Germany
Dr. Benny Israel	Oracie Singapore	Europapark Rust Germany	Onderneming & Kunst Netherlands
Altair Italy	Art-R Ukraine	Daimler Chrysler Berlin Germany	Podimatas Greece
Ripley USA / Great Wolf Lodge Canada	Axente France Demo Mobil France	Tecni Laser Portugal	Capware Italy
Fa. SSF Paris France	Caldera Angola	Marzo Producciones Madrid Spain	TechMen Singapore Airport Singapore
Soluciones Audiovisuales Honduras	VIKING Russia	Villeroy&Boch Germany	Skat Company Russia



OUR
PROFESSIONAL
SOUND
SYSTEMS

SOUND SYSTEMS

Due to our long-standing and close cooperation with the company PR Electronic, we are able to offer our customers customized sound systems that meet their individual needs and desires and can be optimally integrated into any project.

PR Electronic has one of the most rigorous quality standards for developing and producing speaker systems. Together with the most advanced technology PR electronic speaker systems meets the high demands for one of the best products to reproduce any kind of sounds in best sound quality.

PR electronic is manufacturer of advanced speaker systems with the aim to use only the best components, materials and latest construction methods to reach „simply“ reinforcing the original sounds.

Due to this the PR engineers are developing sound systems, electronics and speaker cabinets not for special shades of sound – but to reproduce all audio sources in a perfect way. The only difference for the speakers should be the site-specific acoustic challenge anywhere in the world.

This results in speaker systems which are optimized in sound quality for musicians, contractings, cinemas, installations and touring applications. Further goals of PR Electronic speaker systems are the small size, the low weight as well as the availability of weatherproof systems and the possibility to offer all products in customized colors hence they can be integrated seamlessly into the installation environment.

CUSTOMIZED SOLUTIONS

HIGH-END HOUSINGS



LA2081-HND LINE ARRAY

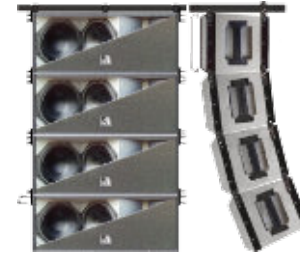

SYSTEM 4-H | PR SYSTEMS



SOUND FLOOR



HB-HYDRO



GERMANY

**FOUNTAINS
& WATER
TECHNIQUE IN
PERFECTION**

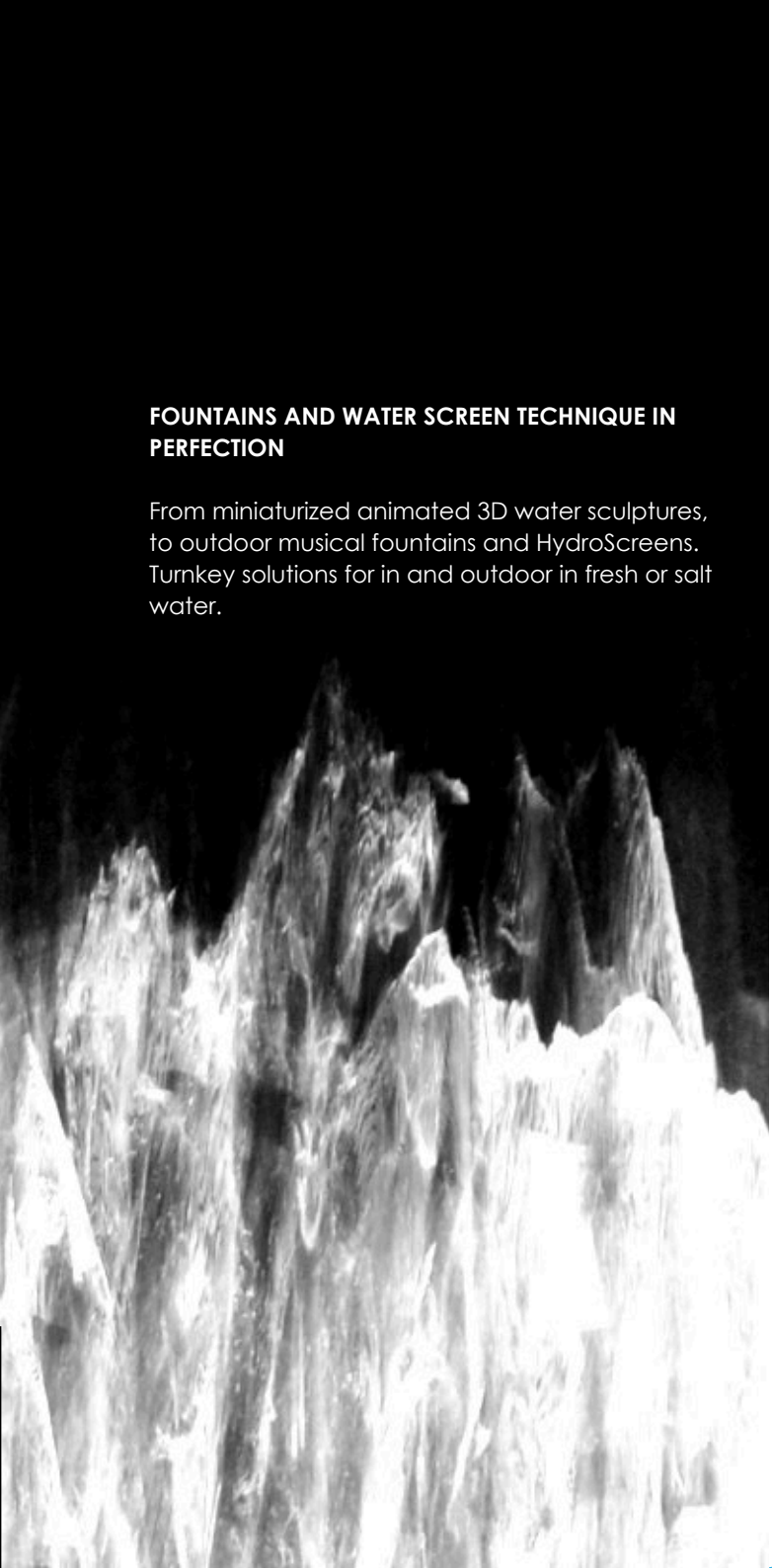

FOUNTAINS AND WATER SCREEN TECHNIQUE IN PERFECTION

From miniaturized animated 3D water sculptures, to outdoor musical fountains and HydroScreens. Turnkey solutions for in and outdoor in fresh or salt water.

OUR EXPERIENCE WITH WATER INSTALLATIONS

Experience the beauty and functionality of HB-Hydro fountain systems. We integrate state-of-the-art water and lighting innovations, tailor-made for a variety of international installations.

From permanent installations in shopping centers and amusement parks to installations at international trade fairs and events, we specialize in the development of fountain systems of all sizes with innovative water and light functions.

Manufactured from high-quality materials, our systems are designed for durability and longevity.

This makes them ideal for different environments around the world, is tailored specifically to your project.

In addition to our patented 3D Hydro-Matrix, which enables unique indoor water installations, you can choose from a variety of water effects for impressive outdoor installations.

The water systems can be combined with pumps of various strengths in order to implement individually controllable shows of all sizes using special control components.

We look forward to inspiring you too!

www.hb-hydro.com

3D HydroMatrix

OUR
UNIQUE
**3D HYDRO
MATRIX**

- » AWARD WINNING PRODUCT 2018
- » Red Dot Design award 2018
- » Industrie Preis best of 2018
- » German Brand Award Innovation 2018
- » German Brand Award Entertainment 2018
- » www.3d-hydromatrix.de

3D HydroMatrix

**WITH OUR 3D HydroMatrix
WE OPEN UP NEW CUSTOMIZED DESIGN POSSIBILITIES.
YOU HAVE NEVER SEEN BEFORE. WATER & LIGHT COM-
BINED AS ANIMATED 3D SCULPTURES.**

UNIQUE

For the first time pixel accurate videos and pictures can be combined with a third dimension, by using the height of a water fountain. The minimal pitch between the LED water fountain nozzles allows the realization of any 3D surface out of water.

EMOTIONAL

Water and light, combined as animated 3D sculptures. Geometrical figures, numbers or letters animated 3D logos or flights through fantastic 3D landscapes made from water and light offer borderless options, as well as new, never seen before, interactive possibilities.

SMART

It is possible to realize any individual design through the flexible configuration with a single or inline arrangement; for example, as a star or as an area covering matrix.

RELIABLE

Using 24V low voltage and only highest quality materials, safe and durable operation is guaranteed, even under challenging, sophisticated environmental conditions.

3D HydroMatrix

includes all components necessary for operation.

DESIGNED FOR:

- » Shopping malls
- » Hotel lobbies
- » Casinos
- » Amusement parks
- » Leisure baths
- » Wellness oasis
- » Airports
- » etc.



INHOUSE PRODUCTION

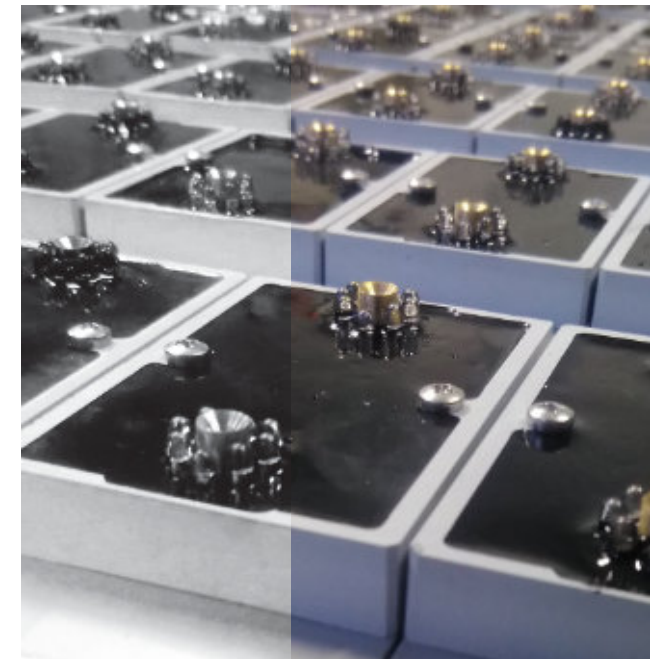
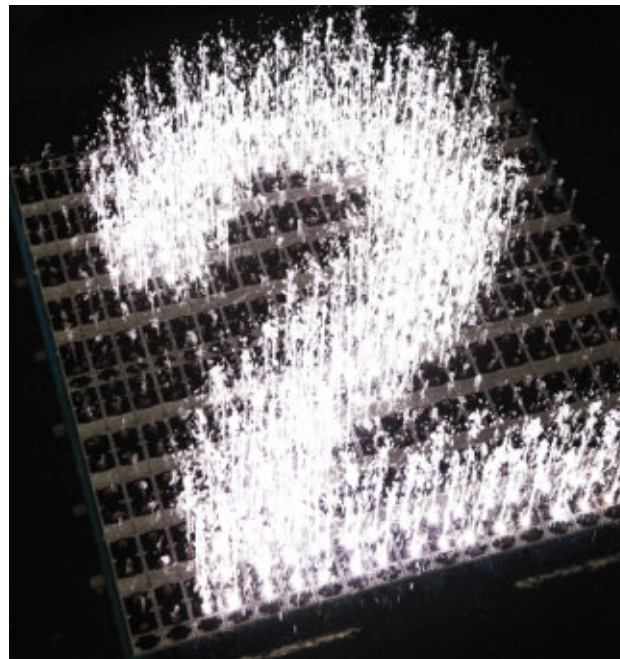
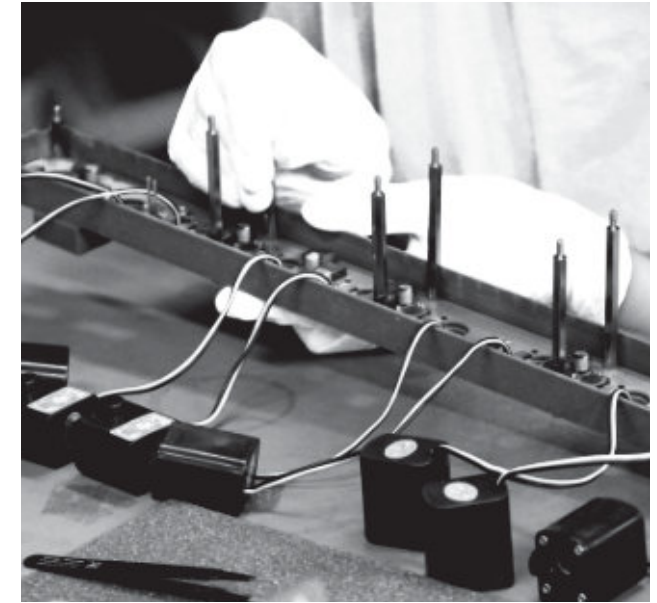

HYDROMATRIX MODULES

3D HydroMatrix HD

- » 250 mm x 500 mm x 100 mm (L x W x H)
- » 50 LED pixel RGBW (900 LED)
- » 50 independent controllable fountains
- » From 1cm up to 1,5m height
- » Pixel & fountain pitch 50mm
- » DMX RDM incl. auto addressing



1 X 1m HD / 40 modules HD



1 X 1m HD / 40 modules HD

3D HydroMatrix SD

- » 500 mm x 450 mm x 100 mm (L x W x H)
- » 25 LED pixel RGBW (225 LED)
- » 25 independent controllable fountains
- » From 1cm up to 1,5m height
- » Pixel & fountain pitch 100mm
- » DMX RDM incl. auto addressing

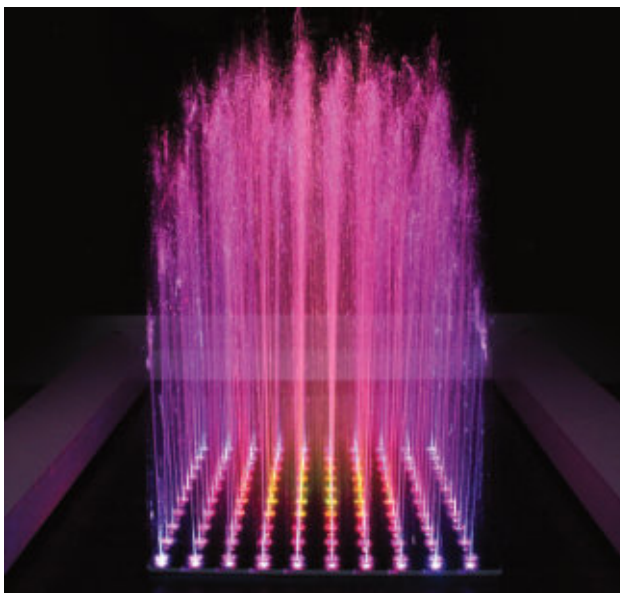
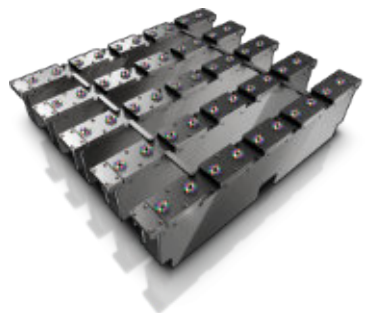

1 X 1m SD / 20 modules SD



1 X 1m SD / 20 modules SD

HydroMatrix MODULES

3D HydroMatrix HD | SINGLE MODULE

- » 500 mm x 50 mm x 100 mm (L x W x H)
- » 10 LED pixel RGBW (90 LED)
- » 10 independent controllable fountains
- » From 1cm up to 1,5m height
- » Pixel & fountain pitch 50mm
- » DMX RDM incl. auto addressing



10 single modules HD

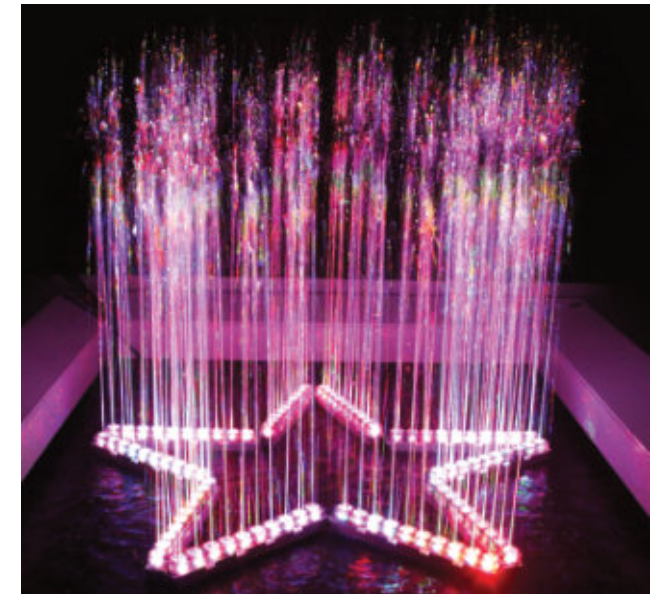

10 single modules HD

3D HydroMatrix SETUP EXAMPLES

- » Single module in row-configuration
- » Flexible configurable and expandable
- » Single module in star configuration
- » Flexible configurable and expandable

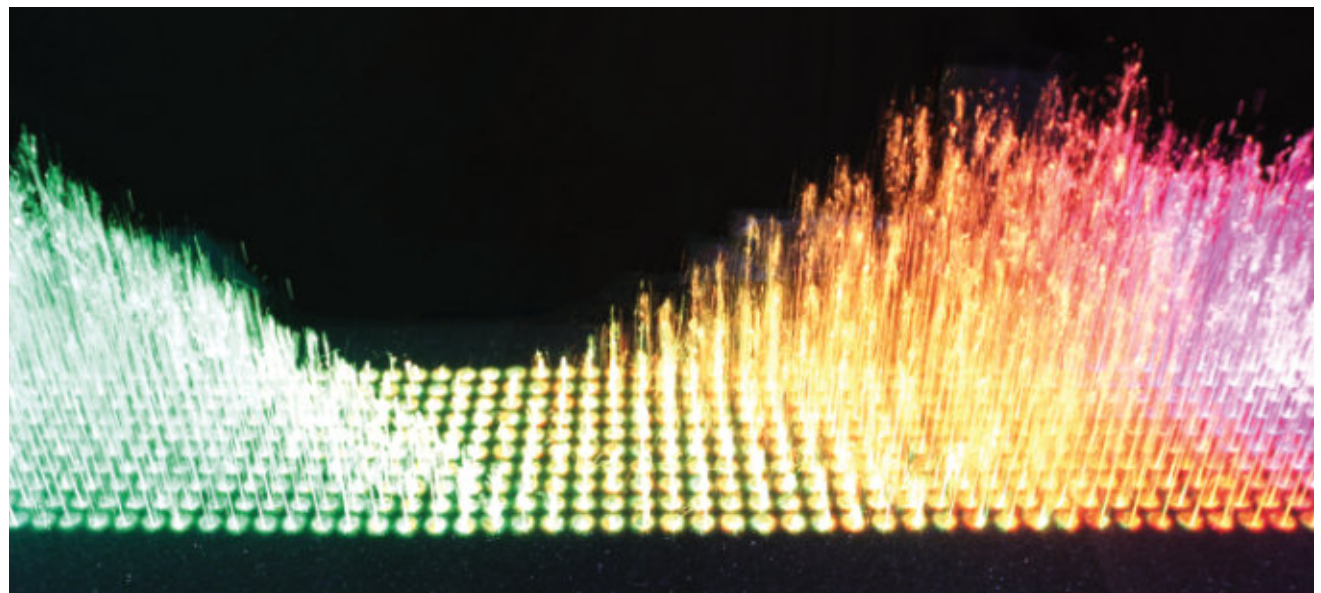

0,5 x 0,5m HD / 70 modules HD

3D HydroMatrix ACCESSOIRES

- » Power supply, cable set, connectors

THE HydroMatrix DryDECK COVER

The **HydroMatrix DryDECK** covers can be freely combined to integrate walkable areas of a water feature into an installation. The required water basin is below the Hydromatrix Cover installation and the water level is returned via the outlets of the nozzles.

» Walk-in HydroMatrix system

- » Stainless steel body parts
- » Single modul, 530 x 530 x 145 mm (1/4 m² HydroMatrix)
- » Can be integrated into the floor with a water basin underneath

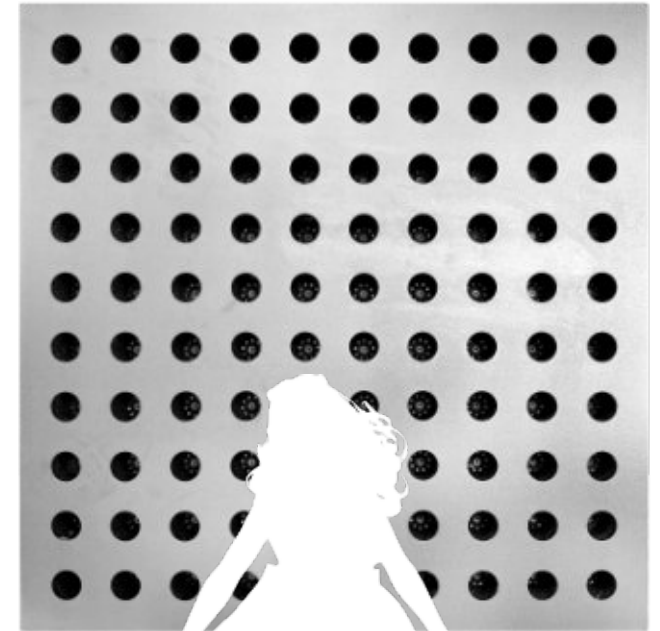

THE HydroMatrix DryDECK VERSION / INSTALLATION EXAMPLE

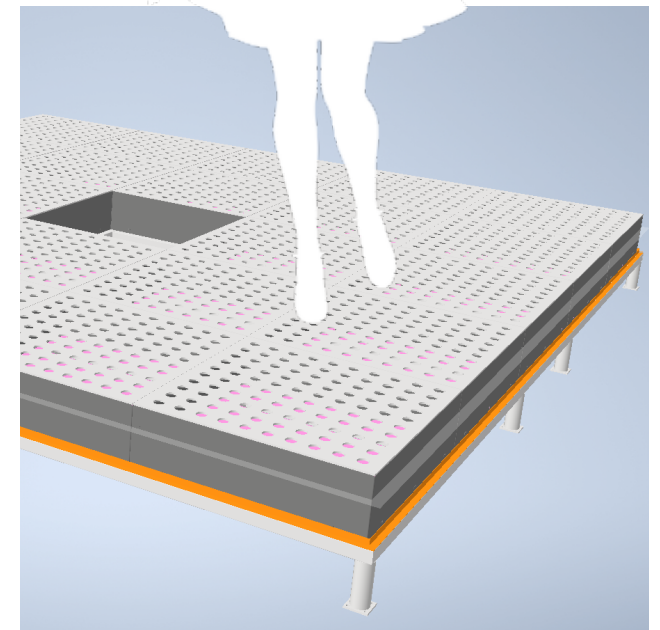
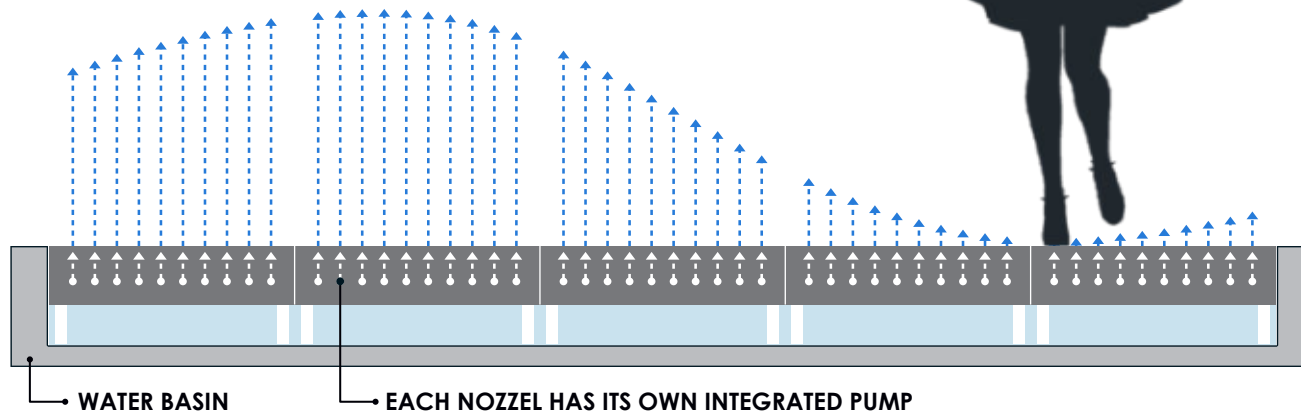

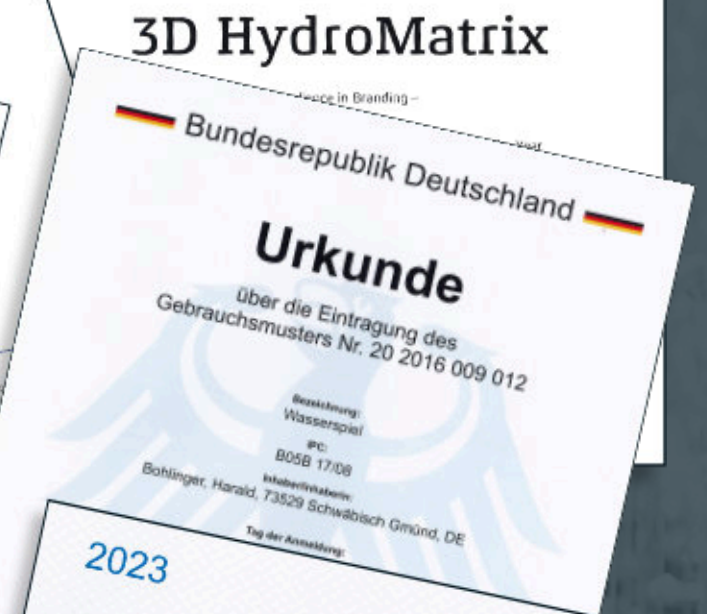

OUR
FASCINATING
HYDRO
SCREENS



NEPTUNE HydroShield

Among projection screens made of fabrics or foils, water screens become more and more popular in the event industry.

The NEPTUNE HydroShield creates a semicircle water wall of up to 20 m height and 50 m width. It is easy to assemble as it can be directly connected to a hydrant or a water pump. The water flow of these systems is up to 3500 l/min at a pressure of 16 bar.

This product is one of the biggest and most spectacular possibilities to produce a projection screen on water basis for sharp laser graphics or video projections. It offers a giant screen of approximately 10x27m or 17x45 (depending on the version) for amazing displays of graphics content. Storytelling, movies or pictures can be displayed and will astonish the audience as the screen is nearly invisible, coming out in the middle of the water.

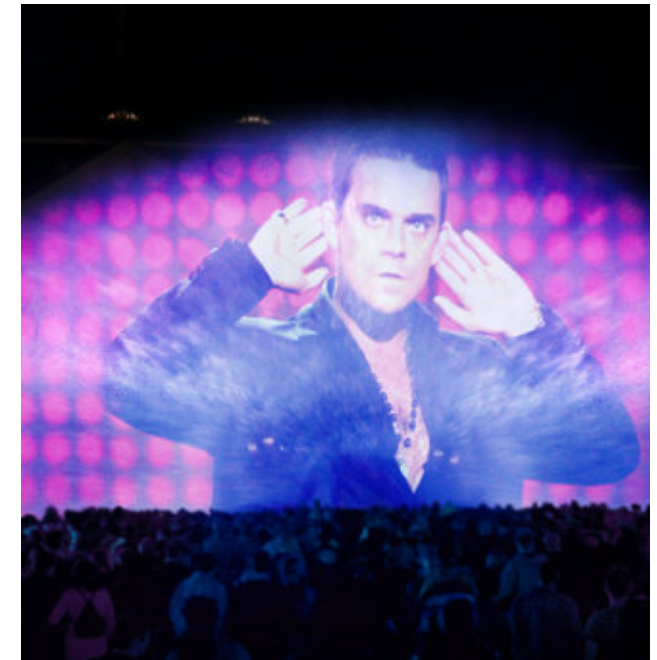

FEATURES

- » Robust stainless steel submersible 55 kW pump
- » 110A, 3 x 400V power connector (also available with different voltage for US)
- » Jet with 5" connector including flow straightener and parabolic shaped stainless steel plate
- » 5" stainless steel piping equipped with flow straightener
- » Star-Triangle startup circuit
- » DMX controllable
- » Sea water resistant



POSEIDON HydroScreen

Besides the Neptune HydroShield the Poseidon HydroScreens are a great feature to use water as a projection surface.

With a big variety of options regarding the number of rows of nozzles and therefore the total number of nozzles (1-3 rows, each equipped with 110 nozzles/meter) the screen can perfectly be adapted for your application even in regards to the material.

Available as straight screens or even as curved screens this product is flexible scalable to any length and is a perfect match for multimedia projects including video or laser projections.

This amazing product will create a nearly invisible screen that will astonish the audience. Different versions of this unique product are available to fit into any application you can imagine. Combining water and light for projection surfaces is a great way to set new standards, especially if the water depth is not enough for using a Neptune HydroShield.

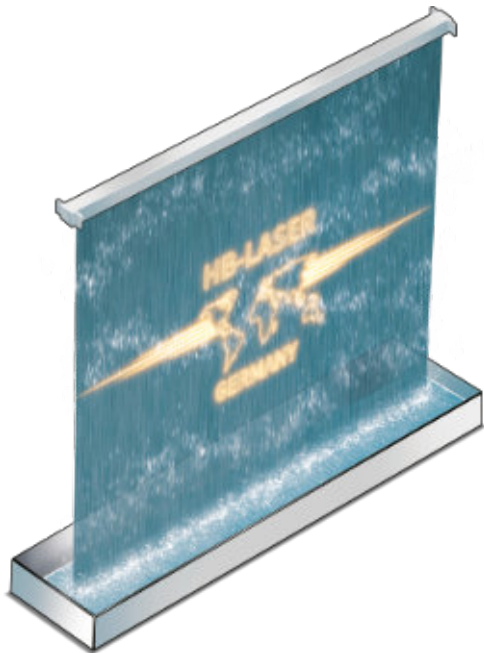

AVAILABLE OPTIONS

- » Curved or straight screens available
- » Customized lengths perfectly matching your requirements
- » 110 to 330 nozzles per meter for sharp video and laser projections
- » DMX controllable
- » Made from aluminum, V2A stainless steel, or V4A stainless steel for challenging environments

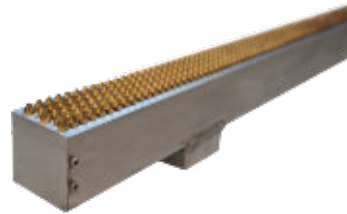

HydroScreen module / Example Aluminium

ACCESSORIES



Poseidon
Submersible Pump 1500



Poseidon
Feed Unit 1500



Included modules



POSEIDON HydroPixel

This product is a special solution of a HydroScreen not made for projections, but allowing to display texts or graphics.

Equipped with 120 single nozzles per meter incredibly looking figures can be displayed in mid-air falling from above.

The whole solution is flexible scalable in length by combining various 0.8m long segments to the size required.

Any of the single valves can be controlled individually to create surreal effects that will be an eye-catcher, no matter where it will be installed.

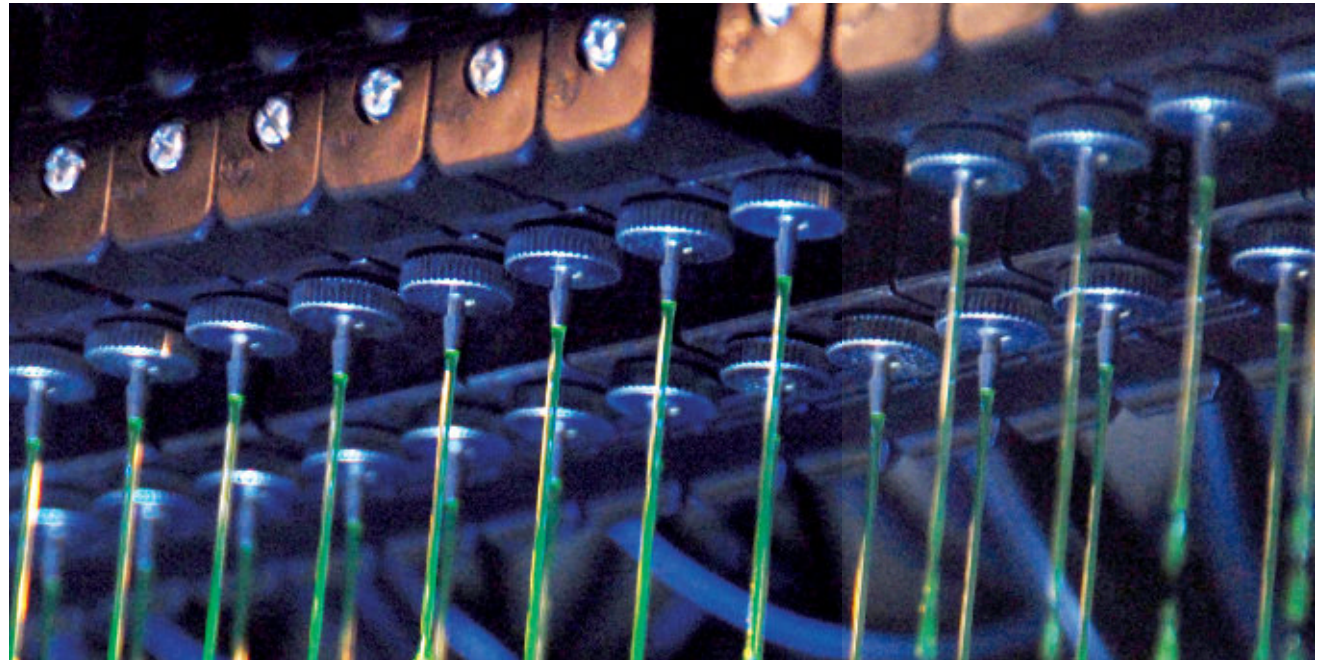

FEATURES

- » 0.8m segments, flexible scalable in length
- » 120 nozzles per meter
- » Display of texts, graphics, figures
- » Individually controllable valves

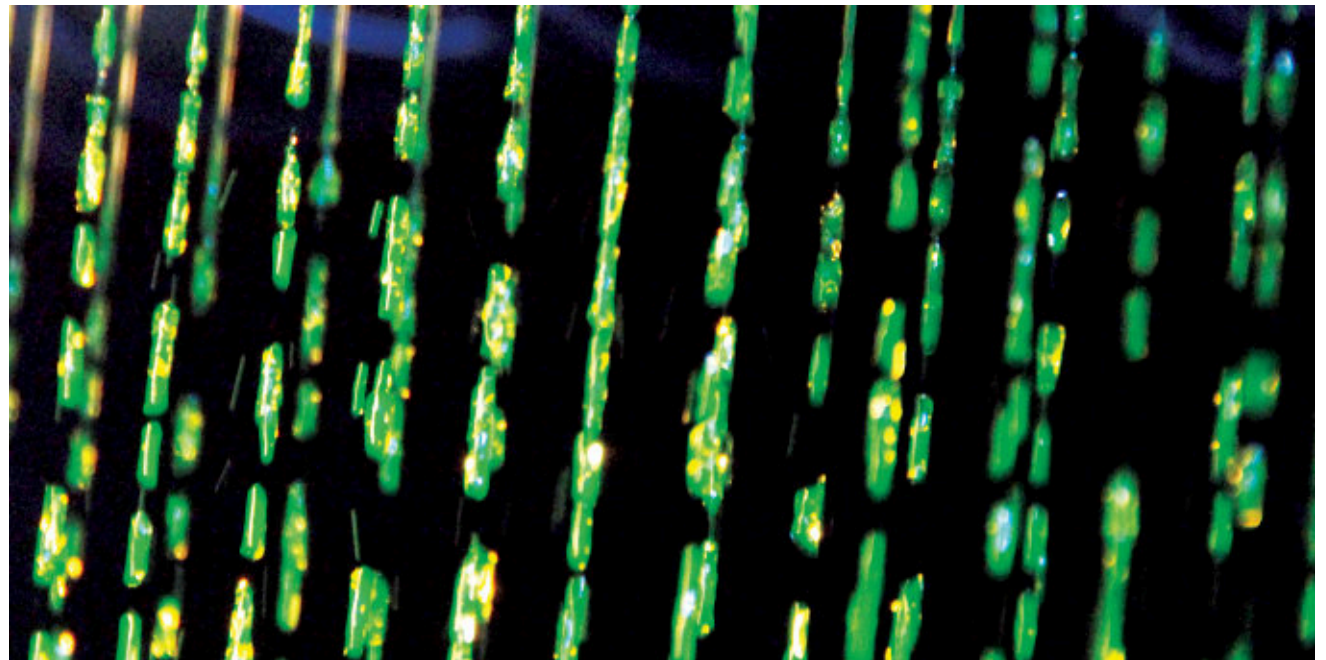
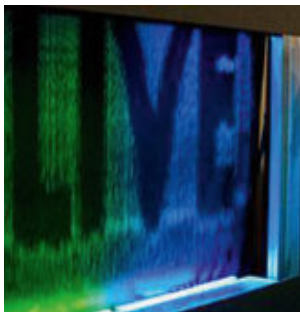

OUR
DISTINCTIVE
WATER
FOUNTAINS



NEPTUNE AquaShutter

Neptune AquaShutter is an amazing solution for high rising, fast shooting spectacularly synchronized water effects.

Due to its 9 single nozzles, combined with a maximum height of 25m and the possibility to adjust each nozzle by +/- 20°, spectacular water effects can be programmed.

With its superior switching time of 0.25 seconds, fast water shots are possible, as well as a constant water stream with an impact unlike any before.

Without using a common valve, but a razor sharp stainless steel blade, HB-Laser set new standards for switching times, which was before only known from small jumping jets.

In combination with Neptune Move Stream, Move Stream 3D and Vario Stream fountains, sophisticated water show setups can be achieved. Due to the large variability of spraying heights a huge number of different water pictures can be realized!

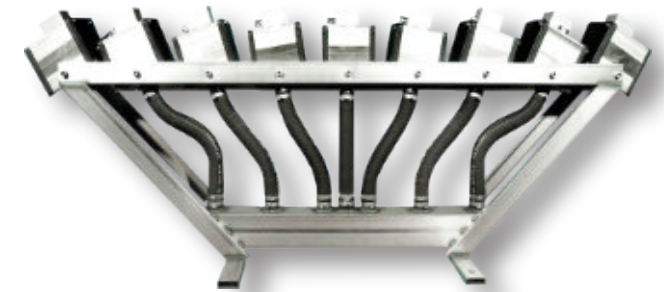

FEATURES

- » 9 pieces 14 mm clear stream nozzles, including water distribution (2x inlet, 9x outlet)
- » Equipped with a frequency controller unit for smooth adaption of the height from 0 to maximum
- » Super fast switching time of only 0.25 seconds
- » HB Motion Control – 150% overload for 60 sec, 5 programmable digital and 2 analog inputs
- » DMX controllable, permanent position controlling
- » Sea water resistant
- » Maximum spraying height of up to 20 m



NEPTUNE OCTOPUS

This special nozzle system is based on the principle of the most beautiful water figures – perfect symmetry. Equipped with 10 individual nozzles, arranged in 2 circles with each 5 nozzles, making it possible to realize astonishing and fascinating water sculptures.

Each nozzle can be moved and positioned perfectly due to servomotors, which allow a pivoting range of 60 degrees at a maximum speed of 0.9 seconds, producing incredible dynamic effects.

In combination with RGBW LED lights and a maximum height of 25 m and more, the Neptune Octopus is a fantastic add on for any fountain setup, not already having such a unique highlight, producing a variety of breathtaking effects.

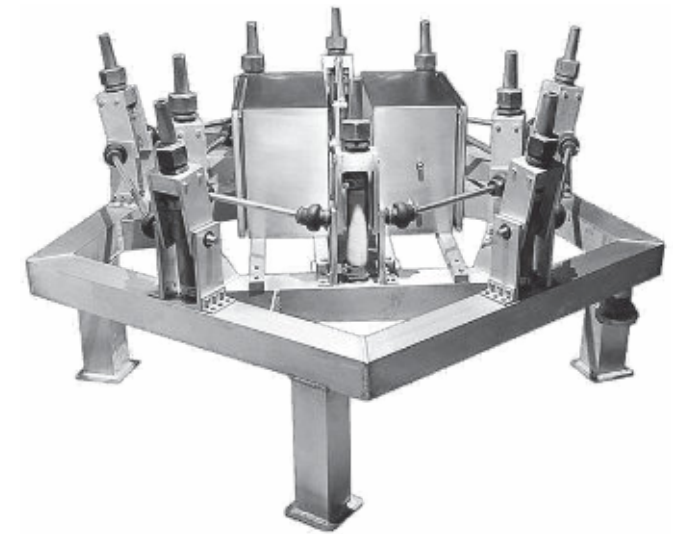

FEATURES

- » 10 nozzles split in 2 circles of each 5 nozzles
- » Equipped with a frequency controller unit for smooth adaption of the height from 0 to maximum
- » Pivoting range of 60° with ultra fast speed of 0.9 seconds
- » HB Motion Control – 150% overload for 60 sec, 5 programmable digital and 2 analog inputs
- » DMX controllable, permanent position controlling
- » Sea water resistant
- » Maximum spraying height of up to 25 m

NEPTUNE ROTOJET / ROTOJET 3D

The Neptune Rotojet is a fascinating, rotating jet combination with 5 nozzles. With the possibility of varying the speed from 0 - 200 rpm in combination with its numerous nozzles, amazing looking pirouettes can be created.

By varying the height and the speed of rotation a wide range of unique and special effects can be programmed.

In combination with the optional RGBW LED lights, colored water pirouettes are the reason for breathtaking moments, when watching the musical and dancing fountain show.

Adaptable water pillar heights from 0 m up to 15 m make this solution a fantastic and flexible product, adding a special value for any water or fountain show in the world.

FEATURES – ROTOJET 3D / ROTOJET 2D

- » 5 pieces 17 mm clear stream nozzles
- » Equipped with a frequency controller unit for smooth adaption of the height from 0 to maximum
- » 0-200 rpm, super fast rotating base
- » HB Motion Control – 150% overload for 60 sec, 5 programmable digital and 2 analog inputs
- » DMX controllable, permanent position controlling
- » Sea water resistant
- » Maximum spraying height of up to 20m

ROTOJET 3D



ROTOJET 2D



NEPTUNE VarioStream

HB-Laser's Neptune VarioStream jets are a great solution for any fountain setup requiring the smooth control of different heights. With the optional RGBW LED lights, fascinating water pillars can be created. By combining different heights and colors in the programming, amazing water and light effects can be created:

Compositions can be realized, surprising spectators. Equipped with different pumps, the range for the maximum height varies from 12m up to 45m. This system was dimensioned to enable rapid motor runs in short intervals. By being able to regulate the water height smoothly, numerous effects can be achieved.

The interconnection by bus system on DMX allows unbelievable dynamic and static effects.

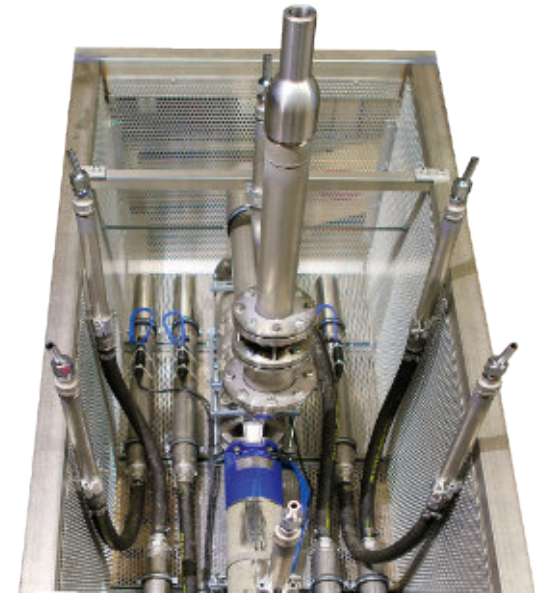

FEATURES

- » Robust stainless steel submersible pumps from 1.5 kW up to 18 kW
- » Equipped with a frequency controller unit for smooth adaption of the height from 0 to maximum
- » Optional RGBW LED lights available
- » HB Motion Control – 150% overload for 60 sec, 5 programmable digital and 2 analog inputs
- » DMX controllable
- » Sea water resistant
- » Maximum spraying height of up to 40 m

NEPTUNE MoveStream 2D

HB-Laser's Neptune MoveStream jets are a great solution for any fountain setup where different heights with the option of swinging on one axis, are required. With the optional RGBW LED lights fascinating dancing effects are possible.

By combining different heights and synchronized or desynchronized movement together with a variety of colors in the programming, amazing water and light compositions can be realized, which will astonish any spectator.

Equipped with different pumps the range for the maximum height varies from 18m up to 45 m. This system was dimensioned to enable rapid motor runs in short intervals. By being able to regulate the water height smoothly, numerous effects can be achieved. The interconnection by bus system on DMX allows unbelievable dynamic and static effects.



FEATURES

- » Robust stainless steel submersible pumps from 2,4 kW up to 18 kW
- » Equipped with a frequency controller unit for smooth adaption of the height from 0 to maximum
- » Flexible moving on Z-Axle within 180° / Maximum speed of 0.8sec. for 180° swing
- » HB Motion Control – 150 % overload for 60 sec, 5 programmable digital and 2 analog inputs
- » DMX controllable, permanent position controlling
- » Sea water resistant
- » Maximum spraying height of up to 45 m

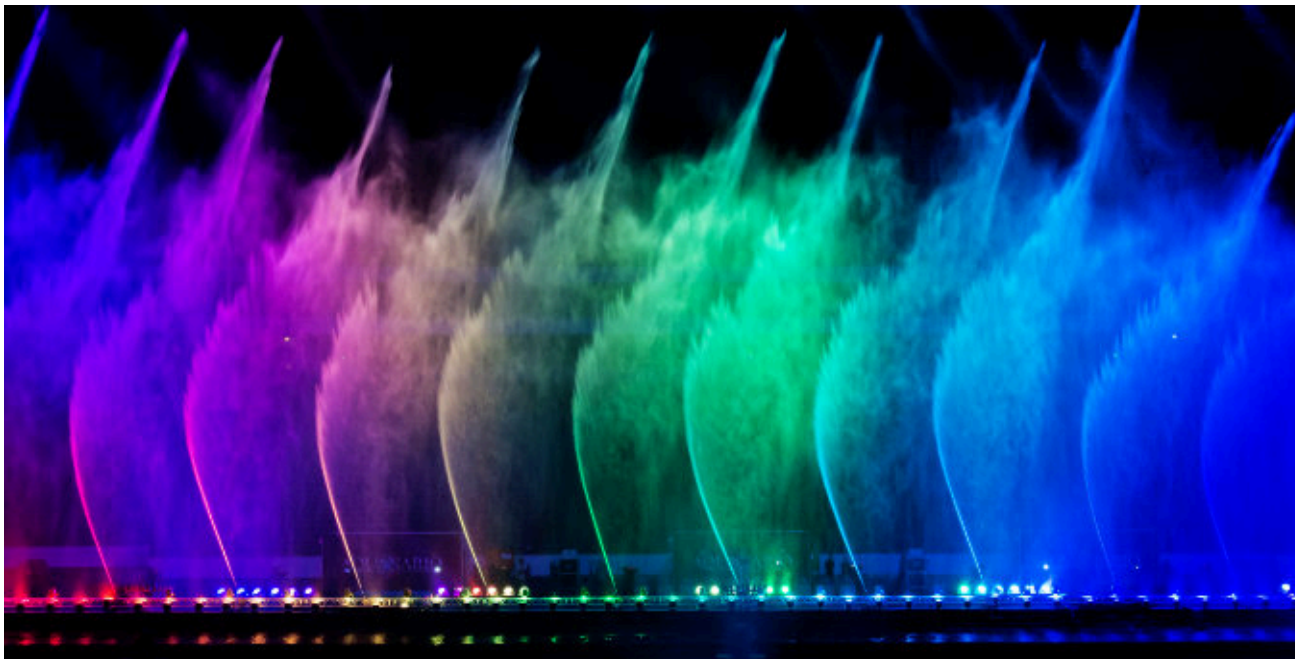

NEPTUNE MoveStream 3D / 3D 3

The Neptune MoveStream 3D series provides amazing features as this is the first product in the world with the possibility of revolving endlessly on its Y axle and 180° swing on its X axle. Using this product will make a massive impact on any fountain installation claiming to be among the top Dancing or Musical Fountain setups in the world.

Nearly cutting off any limitation, the design possibilities are nearly endless and new choreographies, never been there, can be achieved. Combining a swinging nozzle with the option to simultaneously rotate endlessly allows designers to realize nearly any effects they can imagine.

This product will bring fountain dreams come true and is a must have for any superior installation around the globe.

NEPTUNE MoveStream 3D



NEPTUNE MoveStream 3D3



FEATURES 3D / 3D3

- » Endless rotation on Y axle with up to 720° in one second / 180° swing on X axle withing 0.7 sec.
- » Equipped with a frequency controller unit for smooth adaption of the height from 0 to maximum
- » Unique fountain system offering endless programming possibilities
- » HB Motion Control – 150% overload for 60 sec, 5 programmable digital and 2 analog inputs
- » DMX controllable, permanent position controlling
- » Sea water resistant
- » Maximum spraying height of up to 40 m

ADDITIONAL FEATURES 3D3:

- » Additional features Neptun Movestream 3D3
- » Rotating multi-nozzle or fan for unique effects.

NEPTUNE LAMINAR JET

The Neptune LaminarJet offers a unique water feature and impresses with laminar water jets that are up to 4 meters high and 5 meters wide. Low power 800 W pumps produce extremely homogeneous water jets which shoot in arcs through the air and provide an amazing ambience. The laminar jet always hits the same target.

Whether by day or by night, the new Neptune Laminar-Jet offers a spectacular water show with RGBW lighting. The jets are stable enough to transport light like an optical fiber. The Neptune LaminarJet works with integrated RGBW LEDs and they are not illuminated from the outside like other fountains. Because of the illumination from inside, the water jets look like shining glass rods.



FEATURES

- » Stainless steel housing for reliable permanent outdoor installations
- » Incl. 800 W pump
- » RGBW LED IP 68 lighting
- » Shutter and DMX input
- » Up to 4 m high and 5m wide water-beam

NEPTUNE RocketShooter

The Neptune RocketShooter is a small, inexpensive and impressive effect shooter which creates unique water columns with a height of up to 50 m at 4 bar. It's made entirely of stainless steel with a water volume of only 10 liters. Every Shooter has his own water tank. Up to four shoots per minute are possible because of the short filling time of the tanks and a powerful compressor.

Via the illumination with LED IP68 lights in the appropriate colors, the impression of an imposing flame column arises.



FEATURES

- » Integrated solenoid valve IP 68 for underwater mounting
- » Short filling times for up to 4 shots per minute
- » Stainless steel mounting
- » No pump required – the system works with pressured air only
- » Maximum jet high up to 50 m

NEPTUNE RGBW LED

For making water shows even more spectacular. The Neptune RGBW LED provides more than 4 million colors and allows the water jets to shine in a new light.

With 54 High Power LEDs made by Cree, 180 Watt Led power and 14.820 lm light output, the water shows can be redefined. With 50.000 hours LED lifetime with up to 90% less power consumption, a long-term reliable use is guaranteed.

The housing is made of pure, heavy-duty stainless steel to withstand the harshest conditions.

It is designed to protect the light source from corrosion, aggressive water and impacts, requiring minimal maintenance. The exceptional waterproofing offers IP68 protection degree for up to 2 m / 6ft water depth.



FEATURES

- » Incredible small beam angle of 12,5 degrees.
- » Microprocessor on Board – 48 Volt underwater safety bus system
- » Up to 250 meters of cable length between Lamp and Control device
- » Flicker free with perfect RGBW(A) dimming
- » Heavy duty stainless steel housing and bracket, IP68 protection certified



OUR
NEW
**DRY DECK
TECHNOLOGY**

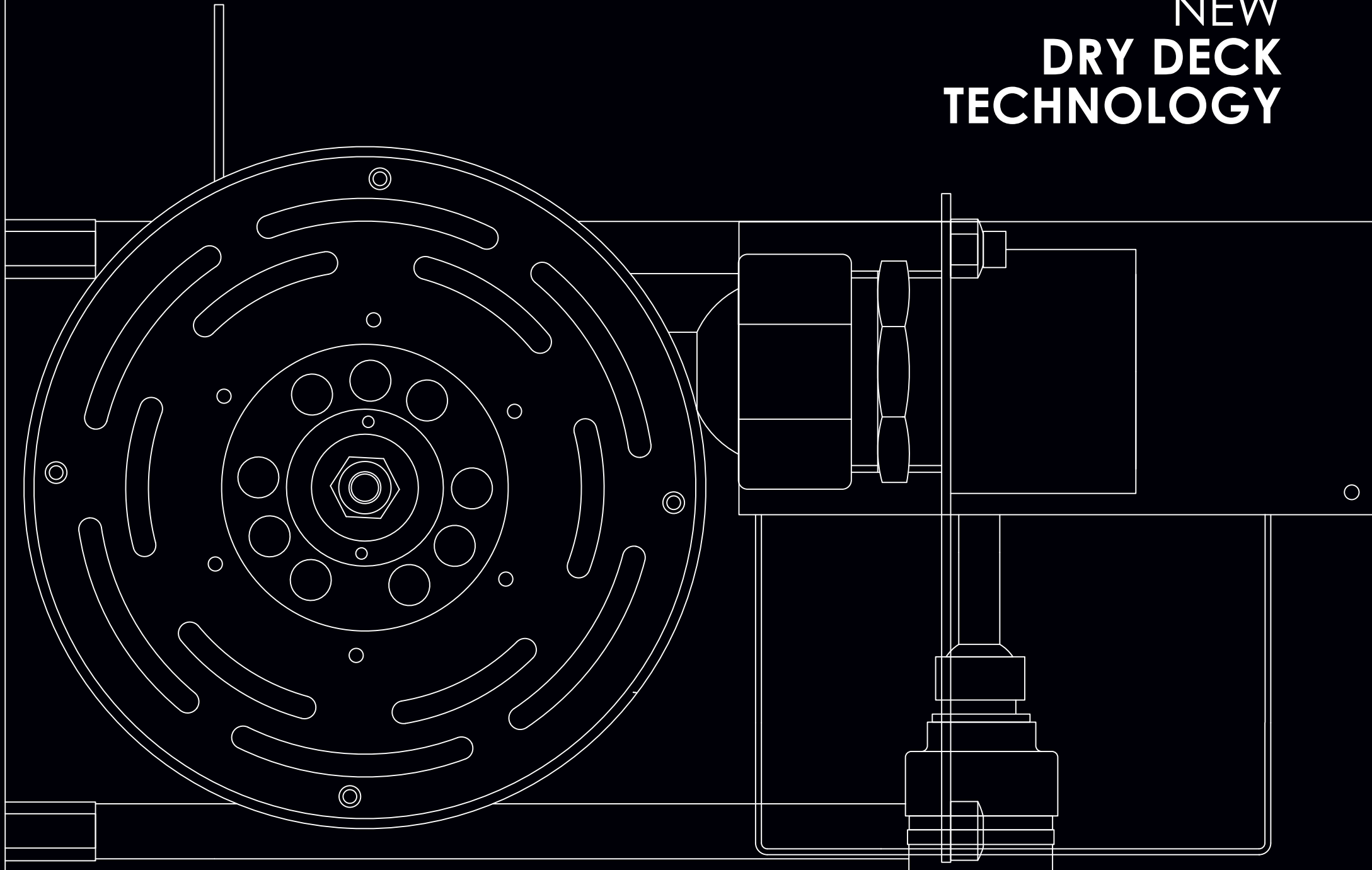

NEPTUNE WATER SWITCH

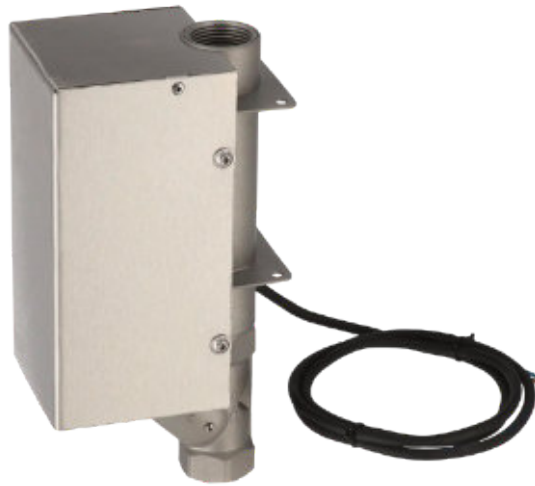

The **Neptune WaterSWITCH** is notable for its durability, reliability, and compact size, making it ideal for confined spaces.

SPECIFICATIONS:

- » 24 VDC 30 W bipolar connection
- » Switching up to 10 times / sec
- » Flow up to 110 LPM
- » 1" connection
- » All stainless steel body parts

ADVANTAGES:

- » DMX controllable or analogue
- » No micron filter required
- » No high pressure pumps to achieve high water jets
- » Very compact size for tight places
- » It is compatible with any nozzle



NEPTUNE JET CUTTER



The **Neptune JetCUTTER** is a high-performance device with a durable, active cutting mechanism that cuts the water quickly and precisely. With the right nozzle, it makes small water balls to pop up to 6 meter height.

ADVANTAGES:

- » Maintenance-free
- » No micron filters; only 3 mm suction strainer required

FEATURES:

- » **Nozzles:** 1" foaming or 1" smooth jet (12 - 20 mm orifice)
- » DMX controllable or analogue

SPECIFICATIONS:

- » 12 / 24 VDC, 20 W bipolar connection
- » Cutting up to 10 times / sec
- » Flow rate of up to 280 LPM
- » Cutting mechanism operates independently of the water level
- » All stainless steel body parts

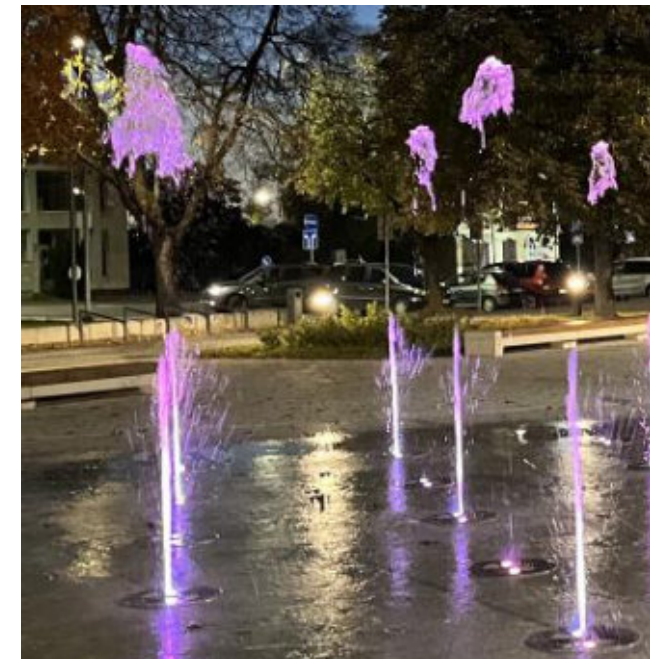



Neptune DryDECK COMPACT / SPECIFICATIONS:

- » 24 VDC 27 W bipolar connection
- » No need for high pressure pumps to achieve high nozzle jets

- » Round 24 W or twin 27 W lights
- » RGB or single color
- » DMX controllable or analogue

- » Quick connection upper part to niche with no hoses
- » Inlets & outlets regarding needs

COVER OPTIONS:

- » Round or square
- » Outlet diameter can be customized
- » Right edge or beveled edge
- » 5 - 6 mm thickness



Neptune DryDECK SWITCH / SPECIFICATIONS:

- » 24 VDC 30 W bipolar connection
- » No need for high pressure pumps to achieve high nozzle jets

- » Round 27 W or twin 9 W lights
- » RGB or single color
- » DMX controllable or analogue

COVER OPTIONS:

- » Round or square
- » Outlet diameter can be customized
- » Right edge or beveled edge
- » 5 - 6 mm thickness

The **Neptune DryDECK** systems are autonomous systems that combine water fountains and LED lighting into a compact design – for spas and adventure pools. They are fully controllable via DMX; perfect unit for stunning water and light effects and to be integrated in walkable areas for an unforgettable experience.

SPECIFICATIONS:

- » Use of 5 - 24 V pump systems
- » 1" water inlet connection
- » Stainless steel body parts
- » Switching up to 10 times / sec.

ADVANTAGES:

- » Compact size & easy to install
- » Switching unit operates water flow up to 110 LPM
- » The systems work water level independent
- » The systems are controlled via DMX
- » **Nozzles:** Clear Jet, Multi Jet, Forming Jet



NEPTUNE DRY DECK CUTTER



The **Neptune DryDECK CUTTER** cuts water fast and accurate – with the right nozzle, it makes small water balls to pop up.

It is fast, robust and durable. Offers a wide variety of water effects, including vertical streams, shooting towers, crystal ball pattern, clashing jets and so on.

The **Neptune DryDECK CUTTER** has a fault-free mechanism, no solenoid valves nor switch parts jamming. It can be equipped with different nozzles and is controllable with DMX.

ADVANTAGES:

- » Durable active cutting mechanism
- » No micron filter required
- » Easy to set up
- » For up to 4 m height water jet

SPECIFICATIONS:

- » 12 / 24 VDC 16 W bipolar connection
- » Cutting up to 10 times / sec.
- » Flow up to 180 LPM
- » 1" connection
- » Cutting mechanism is water level independent
- » 304 grade steel body and parts (316 upon request)

COVER OPTIONS:

- » Shape can be round or square
- » 304 or 316 grade steel
- » 5 or 6 mm thickness

COMPATIBLE NOZZLES:

- » Clear Jet (orifice can be 12 - 20 mm)
- » Multi Jet (bespoke orifice quantity and size)
- » Forming Jet

LIGHTING OPTIONS:

- » Round 27 W or twin 9 W lights
- » RGB or single color
- » DMX controllable or analogue



NOZZELS FOR THE DRY DECK SYSTEMS

Neptune MultiJET

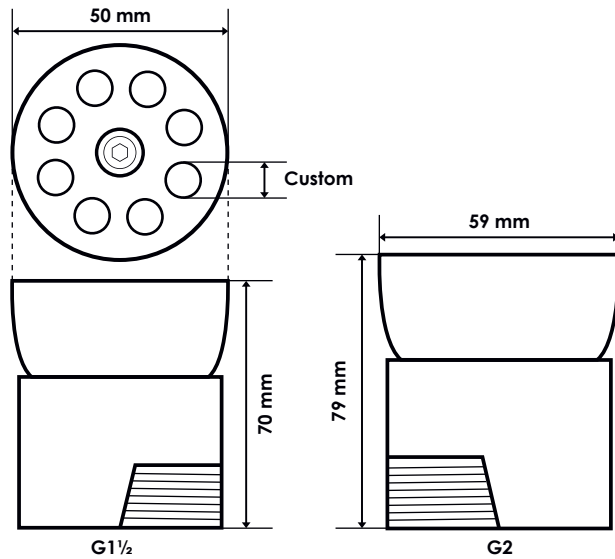

SPECIFICATIONS

- » Outlet holes custom diameter and quantity
- » Easy adjustable built in +/- 60 swivel
- » Internal thread
- » Material: stainless steel or brass

Neptune SwivelFOAM

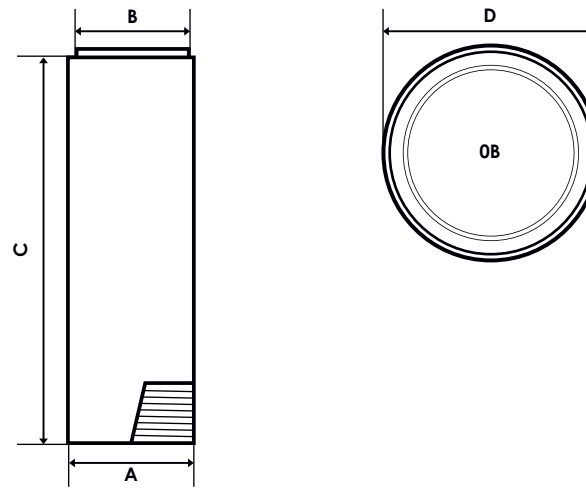

CHARACTERISTICS

- » Ball inside for better air mixture
- » Internal thread
- » Built with strainer
- » Stainless steel material

- A** G1°
B 30 mm
C 90 mm
D 40 mm

JET HEIGHT	LPM	HEAD	BAR.
1.0 m	23	36	45
1.5 m	28	42	57
2.0 m	33	48	69
2.5 m	41	53	77
3.0 m	48	59	85
4.0 m	57	68	101
5.0 m	63	79	117

Neptune SmoothJET

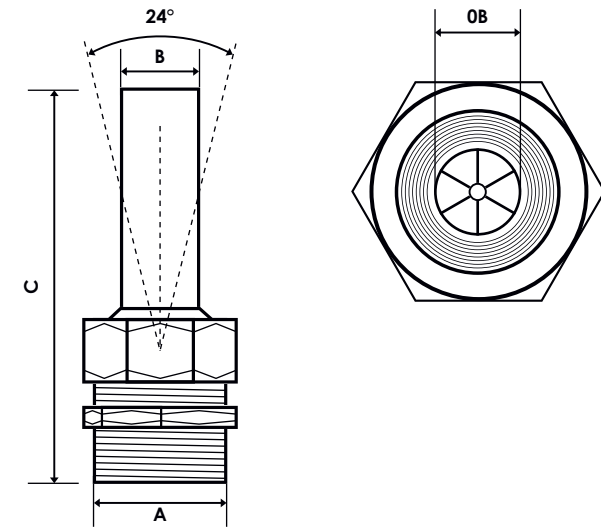

	A	G 1°	G 1°	G 1°	G 1½°	G 1½°	G 1½°
	B	10mm	12mm	14mm	16mm	18mm	20mm
	C	125mm	125mm	125mm	125mm	150mm	150mm
JET HEIGHT		[Lpm]	[Lpm]	[Lpm]	[Lpm]	[Lpm]	[Lpm]
1.0 m		23	36	45	62	68	92
1.5 m		28	42	57	74	83	111
2.0 m		33	48	69	87	99	129
2.5 m		41	53	77	96	110	142
3.0 m		48	59	85	106	123	157
4.0 m		57	68	101	124	142	180
5.0 m		63	79	117	138	156	198
6.0 m		69	91	130	151	167	221
7.0 m		-	102	142	165	182	238
8.0 m		-	-	155	177	206	255
10.0 m		-	-	-	197	234	301
12.0 m		-	-	-	-	261	332
14.0 m		-	-	-	-	287	364

YOUR INSTALLATION OPTIONS & DIFFERENCES

1. OUTDOOR & INDOOR

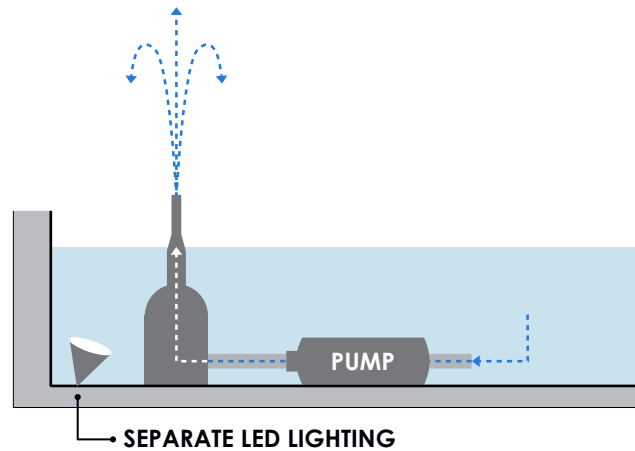

INSTALLATION 1

- » Permanently installed at the bottom of the pool
- » Fountain system with **separate** LED lighting
- » DMX controllable or analogue
- » Interchangeable nozzles
- » Water line just below the nozzle
- » Self-sufficient water pump system

VERSION 1 / OUTDOOR

- » Use of 230 - 400 V pump systems
- » Installation in a non-swimmer area
- » Personal & contact protection through 30 mA earth leakage circuit breaker

VERSION 2 / INDOOR & OUTDOOR

- » Use of 5 - 24 V pump systems
- » Installation in a float area
- » Personal & contact protection thanks to low-voltage technology

2. Neptune DryDECK INSTALLED FREE-FLOATING

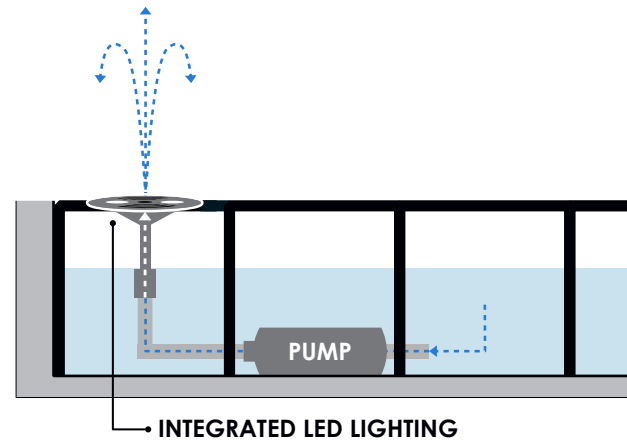

INSTALLATION 2

- » The **Neptune DryDECK** system is installed free-floating on a walk-on grid
- » The system combines fountain and LED lighting
- » DMX controllable or analogue
- » Interchangeable nozzles
- » Self-sufficient water pump system

3. Neptune DryDECK SYSTEM EMBEDDED IN THE FLOOR

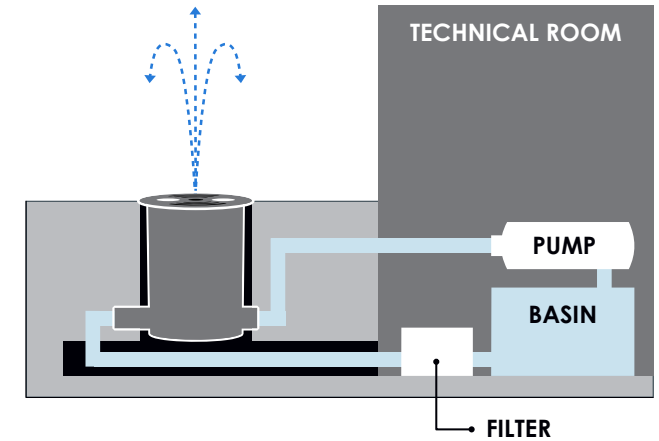

INSTALLATION 3

- » The **Neptune DryDECK** technology is installed in a cup and embedded in a solid base with a defined shape
- » The system combines fountain and LED lighting
- » DMX controllable or analogue
- » Interchangeable nozzles
- » The system also functions as a water drain and channels the surface water into a self-sustaining and piped circuit
- » Water supply via an external basin
- » An additional filter system prevents failure due to a contaminated water circuit
- » Self-sufficient water pump system



THE
HB-LASER
**COMPETENCIES
COMPACT**



HB-PROJECTS



GERMANY

MAKE YOUR PROJECTS UNIQUE

We convert your event, your project, your building or your venue to a real and a multimedia experience.

www.hb-projects.com

HB-LASER



GERMANY

EXCELLENCE IN LASER & MEDIA TECHNOLOGY

Top quality lasers with well thought-out concepts, tailored to the respective requirement. For fixed installations, lasershows and rental.

www.hb-laser.com

HB-HYDRO



GERMANY

FOUNTAINS & WATER TECHNIQUE IN PERFECTION

From miniaturized animated 3D water sculptures, to outdoor musical fountains and HydroScreens. Turnkey solutions for in and out-door in fresh or salt water.

www.hb-hydro.com

CERTIFIED QUALITY & AWARDS

CERTIFIED QUALITY
DIN ISO 9001

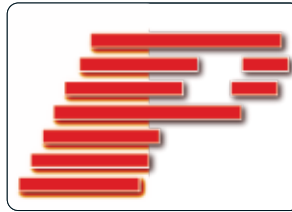

AWARDED

With >40 national & international awards for products installations & shows.

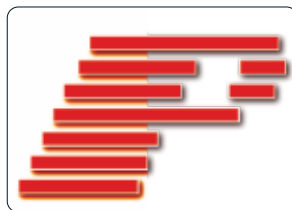

OUR COMPETENCIES, OUR SERVICE & SUPPORT

OUR COMPETENCIES

For over three decades, HB-Laserkomponenten GmbH has set the standard in the world of visual experiences.

With a passion for innovation and an unwavering commitment to perfection, we have established ourselves as a leading force in the creation of show laser systems and the realization of complete multi-media solutions.

From water fountains dancing in perfect harmony, through impressive video mapping and captivating soundscapes, to precise laser projections and spectacular special effects – we bring your vision to life.

HB-Laser delivers turnkey solutions that cover every phase of your project– from the initial idea, through planning and development, to manufacturing, shipping, installation, and on-site commissioning. No matter where in the world you want to enchant your audience, we are your global partner for unforgettable events.

Thanks to our 34 years of experience, we know exactly what it takes to lead projects of any scale to success. Our solutions stand for the highest quality and reliability, making us the preferred partner for museums, planetariums, amusement parks, cruise ships, shopping centers, and tourist attractions worldwide.

OUR SERVICE & SUPPORT

HB-Laser specializes in offering to its customers a wide range of products and services for the show, event and entertainment industry.

THIS INCLUDES:

- » Project planning
- » Turnkey solutions
- » Show production
- » Laser systems
- » Multimedia technology
- » Research and development
- » Customer training
- » Laser safety training
- » Installations
- » Rental services
- » Event planning
- » Event services



HB-LASER



GERMANY

HB-PROJECTS

MAKE
YOUR
**PROJECTS
UNIQUE**

www.hb-projects.com

HB-LASER

EXCELLENCE IN
**LASER &
MEDIA
TECHNOLOGY**

www.hb-laser.com

HB-HYDRO

FOUNTAINS
& WATER
**TECHNIQUE IN
PERFECTION**

www.hb-hydro.com

HB-Laserkomponenten GmbH

Heldenbergstr. 26 | 73529 Schwaebisch Gmuend | Germany | Tel.: +49 7171 104692 0 | Fax: +49 7171 104692 200 | Email: info@hb-laser.com

*All prices are exclusive the actual VAT / sales tax.
Our dealer conditions are only applicable with our pricelist. We reserve the rights for all errors, printing mistakes and technical changes. All of the logos and company names are trademarks or registered trademarks of the respective companies.

HB-Laserkomponenten GmbH
Heldenbergstrasse 26
D-73529 Schwaebisch Gmuend – Germany

Fon: +49 7171 104 692 0 | Fax: +49 7171 104 692 200
Email: info@hb-laser.com
VAT-Ust-Nr.: DE 146 726 060
Town of jurisdiction: Schwaebisch Gmuend
Place of jurisdiction: Local court Ulm | HRB. Nr.: 701745
Managing Director: H. Bohlinger, H. Steybe
www.hb-laser.com

Copyright © 2025 HB-Laser – All rights reserved.